

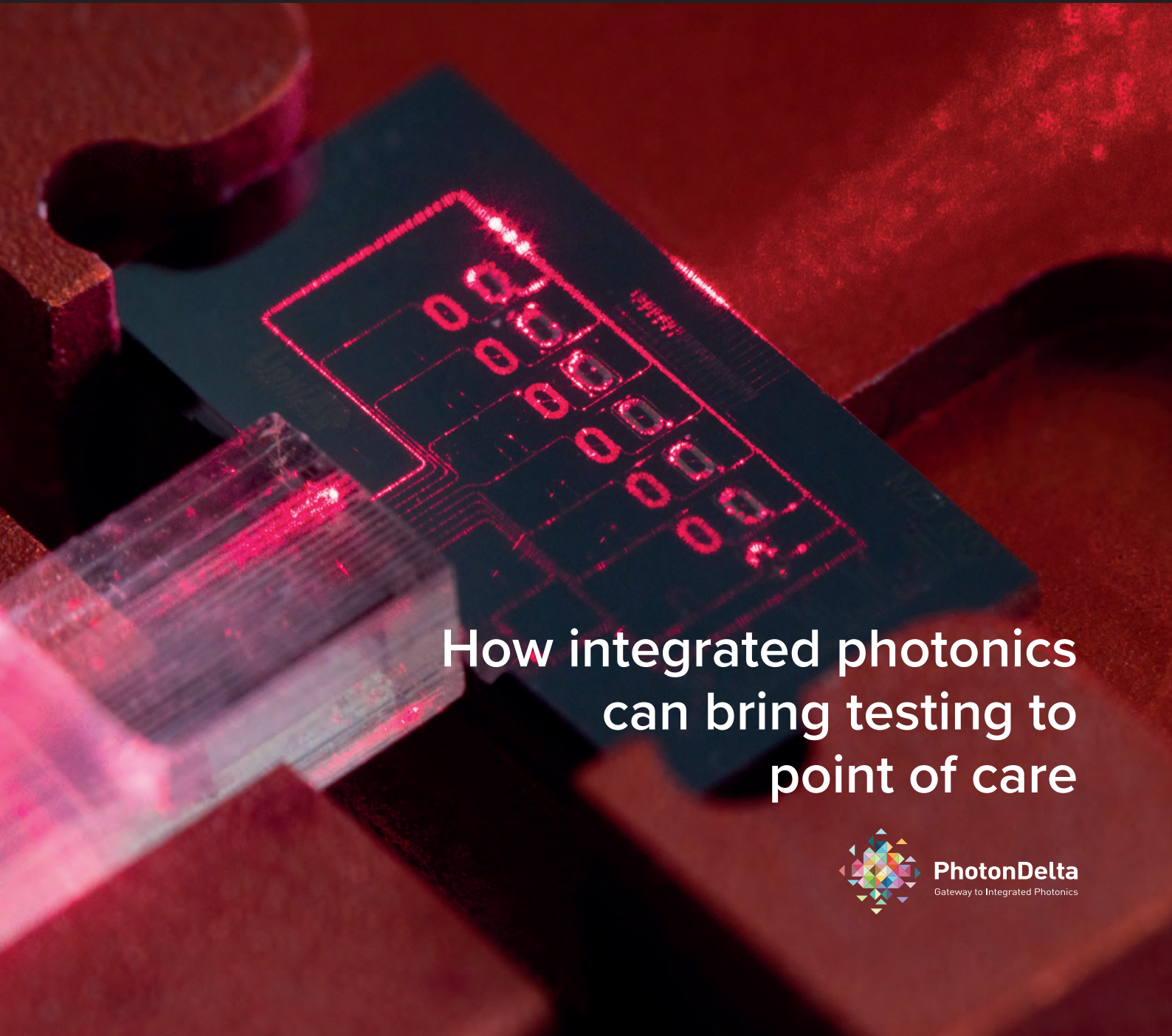

PHOTONIC INTEGRATED CIRCUITS

CONNECTING THE PHOTONIC INTEGRATED CIRCUITS COMMUNITY



How integrated photonics can bring testing to point of care



PhotonDelta
Gateway to Integrated Photonics

ISSUE III 2022

 AN ANGEL BUSINESS COMMUNICATIONS PUBLICATION

PICMAGAZINE.NET

INSIDE

News Review, Features
News Analysis, Profiles
Research Review
and much more...

THE ROLE OF PICS IN THE DATA ROADMAP

Current discrete optical subassemblies can no longer meet future transceiver requirements

OPTICS FOR HYPERSCALE DATA CENTRES

Smaller form factors and faster throughput is leading to the development of next-generation co-packaged optics

PHOTONICS ECOSYSTEM FOR EUROPE

PhotonDelta, secured €1.1b in public and private funds to kick-start a pan-European integrated photonics industry



OPTO-ELECTRONIC CIRCUIT DESIGN SOFTWARE AND PLUG-IN FOR EDA TOOLS

- OPTO-ELECTRONIC FEEDBACK LOOPS
- SEAMLESS EDA INTEGRATION
- SPICE NATIVE OPTICAL COMPACT MODELS
- NONLINEAR OPTOELECTRONIC CIRCUIT SIMULATOR
- PIC SIMULATION FROM MASK LAYOUT

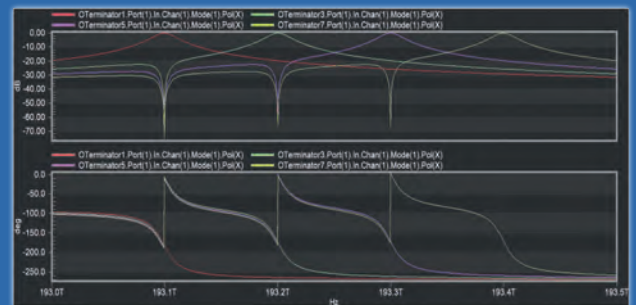
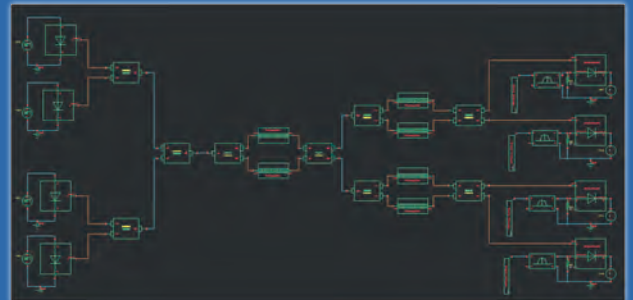

30-DAY FREE EVALUATION

VIEWPOINT

BY MARK ANDREWS TECHNICAL EDITOR

Explore the sky-high future of PICs as ECOC draws near

AS THIS EDITION of PIC Magazine comes together, the European Conference on Optical Communications (ECOC) and its exhibit programme are mere weeks away. Leading into this event focused on European photonic innovation, PIC Magazine is overflowing with feature articles highlighting the breadth and depth of ways that integrated photonics is shaping the future of EU industry.

According to PhotonDelta, by 2030 the continent will have a pan-European integrated photonics industry that the organization expects will produce upwards of 100,000 wafers a year for myriad applications. In April this year, Photon Delta received €1.1 billion in public and private funds to support jump-starting photonics research programmes, manufacturing and adjacent business ventures needed to bring the essential elements of industry together across participating European nations. The aim isn't to have every single element of photonics manufacturing entirely within European borders, but to have essential strategic elements in place for a robust photonic future.

Researchers from Yole Developpement dive into the growing optical transceiver market, projecting that by 2027 transceiver sales will surpass the \$24 billion mark driven by continuing data demands from social networking, business communications, ultra-high definition video, e-commerce and gaming, not to mention artificial intelligence (AI) and a host of sensor/actuator applications across the IoT and IIoT.

In a new article from EPIC—the European Photonics Industry Consortium—the ongoing development of high volume manufacturing of co-packaged optics (CPO) across multiple European countries and companies is highlighted. In another CPO article, POET Technologies describes the development and



demonstrations of its unique optical interposer that utilizes a CMOS-based design for wafer scale passive assembly of electronic and photonic devices. POET believes their approach can substantially reduce the amount manufacturers spend to assemble each module. At present, 70 percent of a device's costs ties back to assembly; the POET approach slashes assembly costs to just 20 percent.

Also in this edition, PIC Magazine explores ways modeling Silicon Photonics (SiP) helps optimize yield and further ways that co-packaged optics are benefitting the development of hyperscale data centres.

We delve into ways that PIC T&M must evolve to meet both passive and active component testing requirements and ways that PICs are taking flight aboard space probes and in commercial aviation.



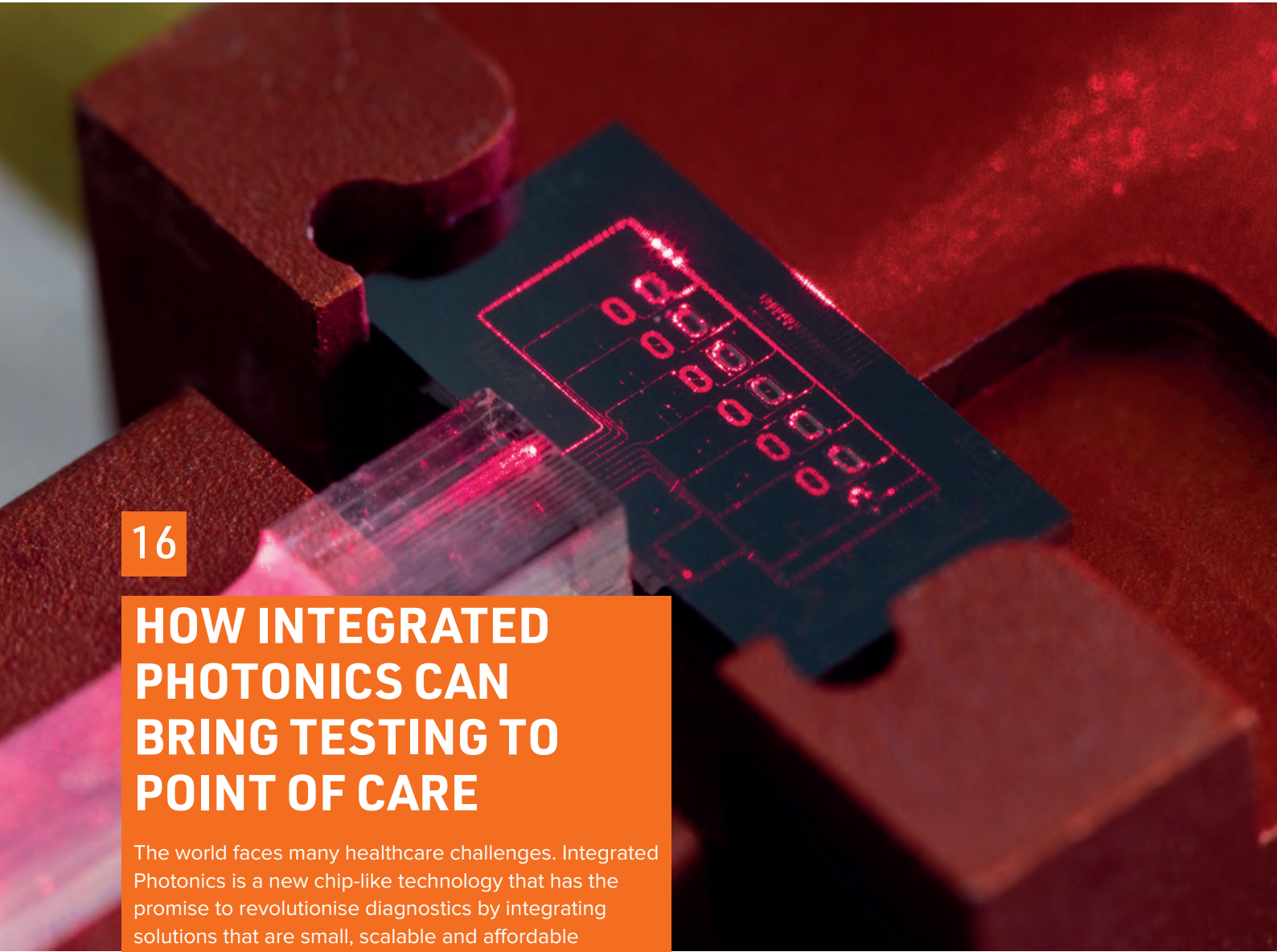

16

HOW INTEGRATED PHOTONICS CAN BRING TESTING TO POINT OF CARE

The world faces many healthcare challenges. Integrated Photonics is a new chip-like technology that has the promise to revolutionise diagnostics by integrating solutions that are small, scalable and affordable

14 Building a photonics ecosystem for Europe

By 2030, PhotonDelta intends to have created a pan-European integrated photonics industry that will churn out 100,000 wafers a year



42

20 Modeling silicon photonics process parameter variations

The estimation of yield and optimization of photonic integrated circuit (PIC) design require ability to accurately account for variations in the SiPh technological parameters

24 How a hybrid integration platform for co-packaged photonics solves many chip industry problems

When industry leaders gathered in San Diego for the 2022 Optical Fiber Communication Conference, several of them reacted with amazement and even disbelief when they witnessed demonstrations of the POET Optical Interposer

28 The role of PICs in the data communications roadmap

As bandwidth consumption continues its meteoric rise, the complexity of optical links and the transceivers within them continue to increase in complexity

32 Hybrid photonic integration

Photonic integration at wavelengths outside the classical communications bands in the infrared has the potential to enable new applications in sensing, analytics and quantum technologies

38 Co-packaged optics for hyperscale data centres

The continuing push for greater efficiency, smaller form factors and faster throughput is leading to the development of next-generation co-packaged optics for datacentres and related applications

42 PIC T&M must evolve to meet passive and active component needs

Datacentre developers look to PIC-based transceivers as a means to handle increasingly large volumes through greater efficiency, smaller size and cooler operating temperatures

46 Getting PICs off the ground

PICs based on InP and GaAs prepare to slash the size, weight and power of systems to be deployed in space and on-board aircraft for a variety of sensing applications

NEWS

06 EVG and ITRI expand heterogeneous integration partnership

07 Trumpf VCSELs to fly to space in quantum sensors

08 DustPhotonics and MaxLinear to demo integrated laser solution



10 Lumentum completes NeoPhotonics acquisition

Physik Instrumente expands German HQ

12 Optical transceiver market to reach \$24.7B in 2027



Technical Editor		
Mark Andrews	mark.andrews@angelbc.com	+44 (0)1291629640
Contributing Technical Editor		
Richard Stevenson	richard.stevenson@angelbc.com	+44 (0)1923 690215
Sales & Marketing Manager		
Shehzad Munshi	shehzad.munshi@angelbc.com	+44 (0)1923 690215
Sales Executive		
Jessica Harrison	jessica.harrison@angelbc.com	+44 (0)2476 718209
Publisher		
Jackie Cannon	jackie.cannon@angelbc.com	+44 (0)1923 690205
Design & Production Manager		
Mitch Gaynor	mitch.gaynor@angelbc.com	+44 (0)1923 690214

Chairman	Stephen Whitehurst	stephen.whitehurst@angelbc.com	+44 (0)2476 718970
CEO	Sukhi Bhadal	sukhi.bhadal@angelbc.com	+44 (0)2476 718970
CTO	Scott Adams	scott.adams@angelbc.com	+44 (0)2476 718970

Published by
Angel Business Communications Ltd
6 Bow Court, Fletchworth Gate, Burnsall Road,
Coventry CV5 6SP, UK.
T: +44 (0)2476 718 970
E: info@angelbc.com



PIC Magazine is published four times a year on a controlled circulation basis. Non-qualifying individuals can subscribe at: £105.00/e158 pa (UK & Europe), £138.00 pa (air mail), \$198 pa (USA). Cover price £4.50. All information herein is believed to be correct at time of going to press. The publisher does not accept responsibility for any errors and omissions. The views expressed in this publication are not necessarily those of the publisher. Every effort has been made to obtain copyright permission for the material contained in this publication. Angel Business Communications Ltd will be happy to acknowledge any copyright oversights in a subsequent issue of the publication. Angel Business Communications Ltd © Copyright 2022. All rights reserved. Contents may not be reproduced in whole or part without the written consent of the publishers. The paper used within this magazine is produced by chain of custody certified manufacturers, guaranteeing sustainable sourcing. US mailing information: Pic Magazine, ISSN 1096-598X, is published 4 times a year, March, May, August and December by Angel Business Communications Ltd, Unit 6, Bow Court, Fletchworth Gate, Burnsall Rd, Coventry CV5 6SP, UK. The 2022 US annual subscription price is \$198. Airfreight and mailing in the USA by agent named Air Business Ltd, c/o Worldnet Shipping Inc., 156-15, 146th Avenue, 2nd Floor, Jamaica, NY 11434, USA. Periodicals postage paid at Jamaica NY 11431. US Postmaster: Send address changes to Pic Magazine, Air Business Ltd, c/o Worldnet Shipping Inc., 156-15, 146th Avenue, 2nd Floor, Jamaica, NY 11434, USA. Printed by: The Manson Group. © Copyright 2022. We strive for accuracy in all we publish; readers and contributors are encouraged to contact us if they recognise an error or omission. Once a magazine edition is published [online, in print or both], we do not update previously published articles to align old company names, branding, marketing efforts, taglines, mission statements or other promotional verbiage, images, or logos to newly created or updated names, images, typographic renderings, logos (or similar) when such references/images were accurately stated, rendered or displayed at the time of the original publication. When companies change their names or the images/text used to represent the company, we invite organizations to provide Angel Business Communications with a news release detailing their new business objectives and/or other changes that could impact how customers/prospects might recognise the company, contact the organisation, or engage with them for future commercial enterprise.

EVG and ITRI expand heterogeneous integration partnership

EVG's advanced wafer bonding and lithography systems now installed at ITRI's state-of-the-art facility

EV GROUP (EVG), a supplier of wafer bonding and lithography equipment, has announced that it has expanded its collaboration with the Industrial Technology Research Institute (ITRI) in Hsinchu, Taiwan, on developing advanced heterogeneous integration processes.

With the support of the Department of Industrial Technology (DoIT) of the Ministry of Economic Affairs (MOEA), Taiwan, ITRI established the Heterogeneous Integration Chip-let System Package Alliance (Hi-CHIP) to help create an ecosystem covering package design, testing and verification, and pilot production, to achieve the goal of supply chain localisation and expand business opportunities.

As a member of the Hi-CHIP Alliance, EVG has provided several

of its advanced wafer bonding and lithography systems, including the LITHOSCALE maskless exposure lithography system (pictured above), EVG850 DB automated debonding system, and GEMINIFB hybrid bonding system. The installation of these high-volume-manufacturing platforms at ITRI's state-of-the-art facility will help enable EVG's and ITRI's shared customers to accelerate the development and transfer of new heterogeneous integration processes from R&D to customers' fabs.

Robert (Wei-Chung) Lo, deputy general director of Electronic and Optoelectronic System Research Laboratories at ITRI said: "Having the same fully automated high-volume-manufacturing systems in our research facility that our customers have in their fabs, including these new wafer bonding and lithography solutions from

Key to our Triple-i philosophy of invent-innovate-implement is our focus on engaging with world-leading research institutes, like ITRI, to accelerate the development and commercialisation of new technologies that drive future innovations in the semiconductor industry

EV Group, enables our customers to immediately transfer process recipes developed at ITRI to their own fabs – providing short ramp-up time from lab to fab."

"Key to our Triple-i philosophy of invent-innovate-implement is our focus on engaging with world-leading research institutes, like ITRI, to accelerate the development and commercialisation of new technologies that drive future innovations in the semiconductor industry," stated Hermann Waltl, executive sales and customer support director and member of the executive board at EV Group.

"Our ongoing collaboration with ITRI gives us access to world-class research expertise and further enhances our process support infrastructure in Taiwan, which EVG has significantly expanded over the years to better meet the growing needs and challenges that our customers and partners in the region face. This includes our exceptional process and application engineering team based in multiple locations across Taiwan, which complements the services provided at EVG's Heterogeneous Integration Competence Centre at our headquarters in Austria."



Trumpf VCSELs to fly to space in quantum sensors

First satellite controlled by quantum technology is scheduled to be launched into space in 2027

TRUMPF PHOTONIC COMPONENTS, has developed a high-power, single-mode VCSEL to be implemented in an altitude gyroscope sensor suitable for use in space. In a few years, the satellite with the quantum-based gyroscope should fly into space to generate highly precise attitude determination.

The development is part of a €28 million subsidy project called QYRO, strongly supported by the Federal Ministry of Education and Research in Germany. There are a number of partners in the project including quantum technology start-up Q.ANT, Bosch, Trumpf and the German Aerospace Center (DLR). The aim is to use quantum technology-based sensors to achieve high-precision attitude control of miniaturised satellites. The sensors enable the satellites to be aligned with each other and thus enable a high-speed connection for data communication.

The newly developed single-mode VCSEL is a 795 nm device with 10 mW of output power. This is ten times higher than the laser power this technology was able to offer in the past, according to Trumpf.

The company says the VCSEL technology delivers the required stability over a wide range of temperatures and robustness demanded by this space application. The breakthrough in compactness and cost enabled by the VCSEL technology will also open up more applications in mass markets. Highly precise gyroscopes can be used in industry, logistics or even in autonomously driving cars.

“It’s great to be part of the subsidy project, and to combine various fields of expertise, push for innovations and



strengthen Germany as photonics hub”, says Berthold Schmidt, CEO at Trumpf Photonic Components. “We can’t wait to see our VCSEL integrated into a mini satellite, to support worldwide high-quality data communication and to improve the availability of internet connections especially in remote regions”, Schmidt adds.

Trumpf Photonic Components is working closely with the Ferdinand Braun Institute, Leibniz Institute for High Frequency Technology, one of the world’s most renowned research institutes for laser diodes. Together with this institute, Trumpf is jointly developing the robust VCSELs with high spectral purity that also meet the demands of quantum technology and space.

Another Trumpf subsidiary based in Berlin will integrate the VCSEL

component into a robust, miniaturised TO package with additional optics and temperature stabilisation. Trumpf brings to the table its innovative assembly and automation technology know-how. Overall, there are five project partners, each bringing their own specialisation, such as Bosch, that is developing a miniaturised, space-compatible measuring cell.

The German Aerospace Center (DLR) will ensure the suitability for space within in QYRO project and is responsible for transporting the satellite into space. The quantum technology start-up Q.ANT is leading the development partnership and assembling the various components of the sensor.

The first satellite controlled by quantum technology is scheduled to be launched into space in 2027

DustPhotonics and MaxLinear to demo integrated laser solution

Combined chipset delivers power and performance for 400G and 800G transceivers

DUSTPHOTONICS, a developer of silicon photonics technology, and MaxLinear, a semiconductor company for communication applications, have partnered to demonstrate a silicon photonics chipset with integrated lasers directly driven from a DSP without the use of any external driver chip.

The MaxLinear Keystone DSP (Digital Signal Processor) and DustPhotonics Carmel Silicon Photonics chip were shown together to support direct-drive operation, which reduces the overall cost and power dissipation of optical transceivers for data communication. This combined solution is ideal for applications such as 400Gb/s and 800Gb/s pluggable modules and on-board optics.

The DustPhotonics chip includes an integrated DFB (Distributed-feedback) laser and DustPhotonics revolutionary Low Loss Laser Coupling technology (L3C), achieving a very efficient coupling of light into the Photonic Integrated Circuit (PIC). This unique technology enables the use of 1 laser for every 4 channels.

The MaxLinear Keystone chip is part of a family of DSPs capable of both 400Gb/s and 800Gb/s operation, based on TSMC's 5nm process. The Keystone DSP provides a rich set of features for transceivers, CPO (Co-Packaged Optics) modules and on-board optics while achieving significantly lower power than competitive solutions. The integrated drivers are optimised for silicon photonics direct-drive and provide the best industry performance for this application.

The combined solution enables performance that significantly exceeds all IEEE specifications. In terms of power

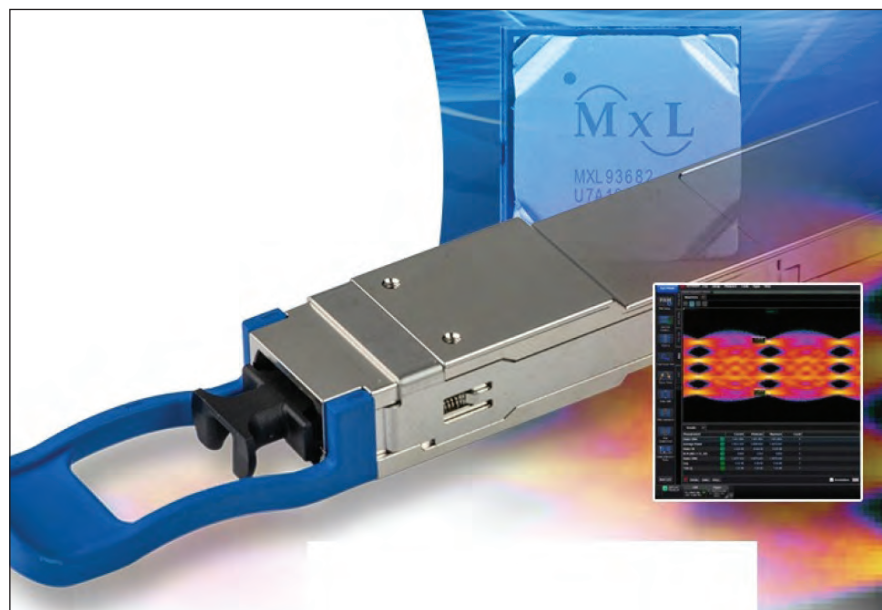

consumption, 400Gb/s transceivers can now be designed to reach sub 7W.

“DustPhotonics is focused on enabling best-in-class Silicon Photonics chips to simplify the efforts of transceiver and systems designers,” said Yoel Chetrit, VP of R&D of DustPhotonics. “Not only can our Carmel chip simplify the overall system design by reducing the total number of lasers to a single laser for 4 channels, but it also eliminates the external driver, which reduces the cost, power and complexity of the overall system.”

“The combination of our Keystone 5nm integrated driver DSPs with DustPhotonics’ silicon photonics demonstrates the significant power and performance advantages achievable with our integrated drivers,” said Drew Guckenberger, VP of Optical Interconnect at MaxLinear. “With double-digit year-on-year growth in market demand for 400Gb/s and

800Gb/s transceivers, this integrated solution can create tremendous value for our customers. We look forward to seeing full transceiver deployments in the near future.”

The DustPhotonics chip includes an integrated DFB (Distributed-feedback) laser and DustPhotonics revolutionary Low Loss Laser Coupling technology (L3C), achieving a very efficient coupling of light into the Photonic Integrated Circuit (PIC)

Sub-Micron Die Attach Solutions

ENABLING THE DIGITAL WORLD

**WORLD CLASS
HIGH PRECISION PLACEMENT**

$\pm 0.2\mu\text{m}@3\sigma$

- Up to 300mm Bonding Station
- Dynamic Placement Alignment Technology
- In-situ Eutectic Bonding Capability
- Flexible Heating Options



Visit us at
Booth # 658

Lumentum Completes NeoPhotonics Acquisition

Lumentum hopes to achieve \$50 million in annual cost savings within 24 months

OPTICAL NETWORKING and laser applications company Lumentum has completed its previously announced acquisition of the laser and optoelectronics firm NeoPhotonics. Both have HQs in San Jose, California.

“I am excited to unite NeoPhotonics’ differentiated products and technology and talented team with those of Lumentum,” said Alan Lowe, Lumentum president and CEO.

“This acquisition better positions us for attractive growth opportunities created

by the digital transformation of work and life, which is driving relentless growth in the needed volumes and performance of cloud and network infrastructure. I welcome our new colleagues to the Lumentum team and want to thank NeoPhotonics’ CEO Tim Jenks and the rest of NeoPhotonics’ leadership team for their contributions in getting us to this important milestone.”

Under the terms of the merger agreement, NeoPhotonics stockholders will receive \$16.00 in cash for each

share of NeoPhotonics common stock in accordance with the terms of the merger agreement. Lumentum anticipates achieving more than an estimated \$50 million in annual run-rate synergies (cost savings) within 24 months of the closing of the transaction. Lumentum financed the transaction consideration with cash from the combined companies’ balance sheets.

Due to the timing of the closing of the NeoPhotonics acquisition, there is no impact to Lumentum’s fiscal fourth quarter 2022.

Physik Instrumente expands German HQ

Creates more than 1,000 square metres of additional production area

Physik Instrumente (PI) has taken a large step towards expanding their production capacities. The company has purchased an additional building close to their headquarters in Karlsruhe, Germany, to which various corporate functions will move.

With this relocation, the specialist for nano positioning, piezo technology, and performance automation will create approx. 1,000 square meters of additional production area, hence rapidly expanding their capacities in Karlsruhe.

“Our markets and the demand for our products and solutions are continuing to grow sustainably at a remarkable rate,” explains PI’s CEO Markus Spanner.

The additional investment of approx. 10 million euros for purchasing the building, as well as its conversion and extension, complements the global

investment package for expanding capacities already started in 2021, which is worth 53 million euros.

“Through purchasing the building, we will be able to use more than 1,000 m² of space for additional workstations in production. There will also be more space for office workplaces. Our focus is on maximum on-time delivery to our customers,” explains Spanner. Increasing the number of employees at PI is also right on track. From the 240 additional jobs planned in Germany for 2022, close to 100 have already been filled. PI is also pushing the capacity expansion at their German sites in Eschbach



and Lederhose as well as at their international sites.

In 2021, the company already increased capacities by approx. 30 percent, hiring more than 170 new employees. All of the investments are the result of the ‘Maximum On-Time Delivery’ initiative, which PI is using to systematically improve their ability to deliver on-time to customers.



www.EVGroup.com

EVG SPOTLIGHTS PHOTONICS

- **Benefit** from recent company initiatives and technologies for photonic devices
- **Leverage** field-proven semiconductor process- and equipment know-how
- **Utilize** our engineering expertise and flexibility to address your manufacturing requirements

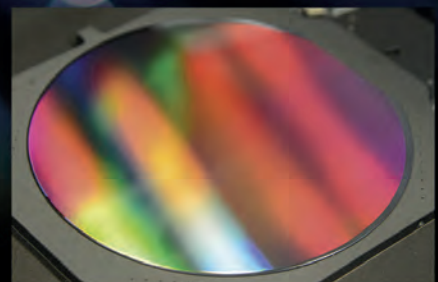

GET IN TOUCH to find out more about how your business can profit from nanoimprinting, wafer bonding and EVG's NILPhotonics[®] Competence Center

www.EVGroup.com

Optical transceiver market to reach \$24.7B in 2027

Increased IP traffic growth creates new demand for datacom and telecom optics, says Yole

THE OPTICAL transceiver market will reach \$24.7 billion in 2027, according to Yole Group's latest research. Social networking, business meetings, video streaming in UHD, e-commerce, and gaming applications continue to drive growth.

In addition, expanding machine-to-machine applications, such as smart meters, video surveillance, healthcare monitoring, connected drives, and automated logistics, contribute significantly to device and connection growth and push the expansion of data centre infrastructure.

Martin Vallo, senior analyst, Photonics, specialising in optical communication and semiconductor lasers within the Photonics and Sensing division at Yole Intelligence, part of Yole Group said: "Revenue generated by the optical transceiver market reached around \$10.4 billion in 2021 and is expected to reach \$24.7 billion in 2027, which is a 15 percent CAGR for 2021-2027. This growth is driven by high volume adoption of high-data-rate modules above 400G by big cloud service operators and national telecom operators requiring increased fibre-optic network capacity."

The evolution of multiple technologies has enabled data rates of 400G, 600G, 800G, and beyond across data centre infrastructure and in long-haul and metro networks.

400GbE deployments are ramping across data centre networks. Many cloud providers and telecom operators are now starting to deploy an 800Gbps optical ecosystem to increase bandwidth capacity and keep pace with the growing demand for data. Optical modules have become an essential technology in telecommunication

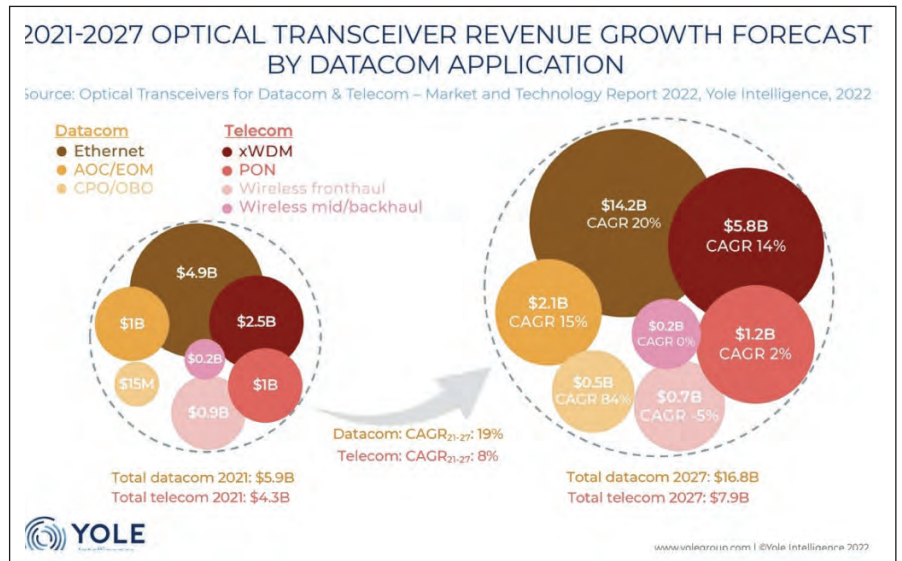

infrastructure. The development of semiconductor technologies such as lasers, modulators, and DSPs has enabled increased bandwidth and accelerated data rates.

Optical interconnects are ubiquitous and are intended to provide high bandwidth even for very short-reach applications, such as high-power computing and AI/ML applications within data centres.

SiPh as a technology platform, co-packaged optics assembly as a new switch architecture, and coherence in compact form factors are the trends that will drive the market for the next five years.

Today's modern Ethernet-switch ASICs providing 25.6 Tb/s total capacity are running at a 50Gbps SerDes lane rate driven by 50G PAM-4 modulation technology. In line cards, a re-timer is typically needed to synchronise PAM-4 data from the switch to the optical interface. In 400G optical modules, an additional silicon gearbox chip

can be used to convert 50G PAM-4 electrical I/Os to 100G per wavelength optical I/Os to connect to 100G single-wavelength optics.

The next generation of ASIC chips expected in 2023 will provide 51.2 Tb/s total capacity and run at a 100Gbps SerDes lane rate.

This significantly simplifies electro-optic conversion within the switch system and accelerates the exchange of high-speed optical modules.

We anticipate high popularity for 800G modules as they take advantage of 100G single-wavelength optics already proven in 400GbE systems and thus can be technically and cost-effectively implemented in QSFP-DD and OSFP form factors.

Yole Group will be collaborating with the China International Optoelectronic Expo (CIOE) to organise the Forum on Optical Transceivers and Silicon Photonics. It will take place on September 8, 2022, in Shenzhen.

LUCEDA

P H O T O N I C S

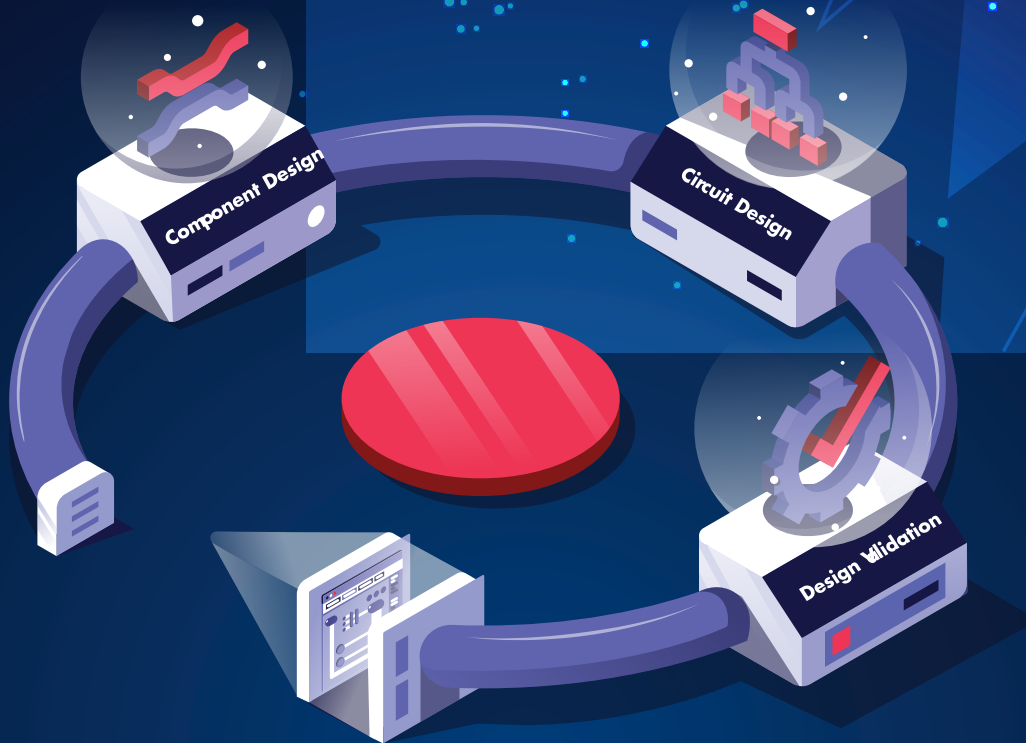

IPKISS Photonics Design Platform

First-time-right photonic IC design software

Automate and integrate all aspects of your photonic design flow in one tool, using one standard language.



IPKISS PDKs

Gain access to a wide range of PDKs.

Design and tape out to your foundry of choice.



Contact us



www.lucedaphotonics.com

Follow us on LinkedIn



Building a photonics ecosystem for Europe

By 2030, PhotonDelta intends to have created a pan-European integrated photonics industry that will churn out 100,000 wafers a year. Here's how, reports **REBECCA POOL**

IN APRIL THIS YEAR, PhotonDelta, of The Netherlands, secured a mighty €1.1 billion in public and private funds to kick-start a pan-European integrated photonics industry. By 2030, the photonics umbrella organisation, which provides InP, SiN and silicon photonics production and prototyping facilities, aims to have created an 'ecosystem' of hundreds of companies delivering more than 100,000 wafers per year, and photonics-related products, to industries worldwide.

As PhotonDelta chief executive, Ewit Roos, highlights, funds will be invested in photonics start-ups and other businesses to scale activities, expand production and research facilities, attract engineers and also to develop, what he describes as, a 'world-class' design library.

"Two to three years ago no-one spoke about strategic autonomy in Europe, but the current chip shortage and today's geopolitical situation have triggered European policymakers to make sure we are not dependent on Asia and the US for this key technology," highlights Roos. "As well as this, we've also seen a need to accelerate the development of photonics technologies in The Netherlands and the rest of Europe."

Indeed, thanks to the likes of Philips and Mathworks, The Netherlands has a rich heritage in tech research and development, with myriad home-grown start-ups already forming the basis of a photonics supply-chain. For example, in The Netherlands alone, LioniX International, Bright Photonics and

Smart Photonics have been pushing back the boundaries of photonics design and fabrication, while Phix has been developing photonic integrated circuit (PIC) packaging processes. Staying in The Netherlands, start-ups and scale-ups such as Surfex, MantiSpectra, QuiX, Effect Photonics, and so many more, have developed PICs for a broad range of applications, whilst across Europe, a vast array of start-ups including aiXscale Photonics, Germany, and Ommatidia LiDAR, Spain, have been following similar trajectories. What's more, Belgium-based imec is home to SiN and SiPh platforms for CMOS-compatible PIC fabrication; and joint European platform for photonic integrated components and circuits, JePPIX, can be used to develop prototypes based on InP and SiN photonics.

"In The Netherlands, we are strong in research, photonics integration and parts of [photonic chip] manufacturing, but you need all kinds of other expertise to make photonic integrated circuits," says Roos. "At PhotonDelta, we want to bring all of this together and increase the pace of development for photonics manufacturing, in both the front-end and back-end... My dream is that we do for photonic integrated circuits what TSMC has done for today's electronic ICs."

Planning the future

Since 2019, PhotonDelta has been investing in in many start-ups, including Effect Photonics, to develop its DWDM optical SoC technology, Phix, with its high volume PIC back-end foundry packaging facility, and Smart Photonics and its InP foundry processes. Looking forward, investment will continue up and down the integrated photonics supply chain, but at faster pace. Roos points to InP production at Smart Photonics' foundry, SiN PIC development at LioniX, and quantum photonic processor development at QuiX, also of The Netherlands, as just a few investment targets. Along the way, PhotonDelta has also been offering the legacy semiconductor industry practice of multi-project wafer runs with partners Smart Photonics, LioniX, imec and JePPIX, to reduce the cost of PIC prototyping. "All these players will be receiving a lot of support from us, and it's also important that we work with imec, as we will then have all the important platforms; CMOS, silicon photonics, InP and SiN," points out Roos. "We're not necessarily doing anything new with these firms, but we are accelerating activities."

➤ A quantum photonic processor from QuiX, of The Netherlands. [Daniel Verkijk, QuiX Quantum]

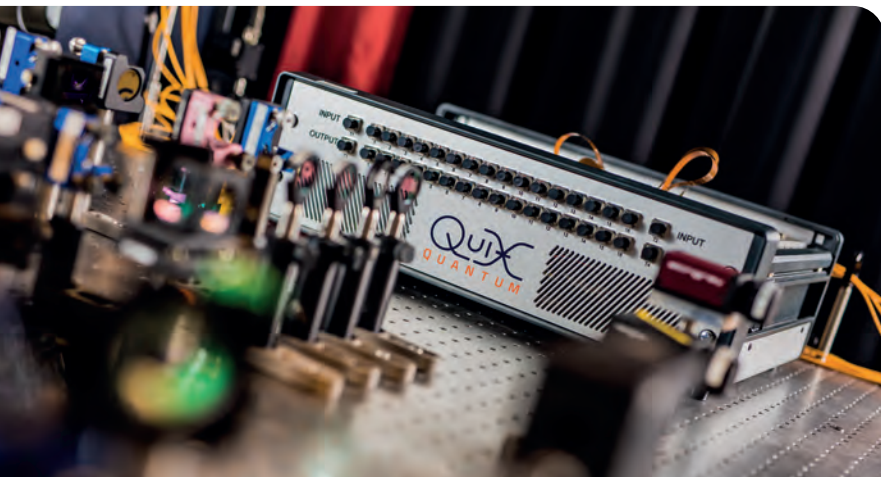

Critically, Roos is keen to ensure that large-scale photonics production is reliable, stable and robust. Looking at wafer production, some 5,000 4-inch InP wafers are currently being manufactured at Smart Photonics, but Roos anticipates some 100,000, 6-inch InP wafers being produced every year come 2030. LioniX could also be churning out up to 50,000 8-inch SiN wafers, a year, by the same time. Meanwhile, Roos hopes to achieve fully-automated, higher-speed back-end production come 2030 with a comprehensive design library and automated wafer-scale, generic, integration technology across silicon, silica and InP substrates. “You can only survive if you have a world-class library of building blocks that can be used in manufacturing,” he says. “We have put a lot of emphasis, in the next six years, on application technology,” he adds. “And to be more focused on what high-volume customers require for next-generation applications, be it for automotives, biosensing, agriculture, quantum photonics – you name it.”

Clearly, a solid pan-European photonics integration supply chain will demand an equally solid workforce. Roos is confident this will follow, and highlights how Dutch photolithography systems manufacturer, ASML, attracts tens of thousands of job applications every year thanks to its attractive working environment and conditions. Still, the PhotonDelta chief executive is keen to keep an eye on the rest of the world.

➤ PIC wafer from one of PhotonDelta’s multi-project-wafer runs – here multiple chip designs from different businesses are combined onto a single wafer to cut prototyping and processing costs.

“European sovereignty doesn’t mean you have to have all of your volume production capacities within European borders – that would be insane and against all economic rules,” he says. “But we need to have strategic assets within our borders so the world also comes to us – and for us, this will be photonics integrated circuits and photonics engines.”

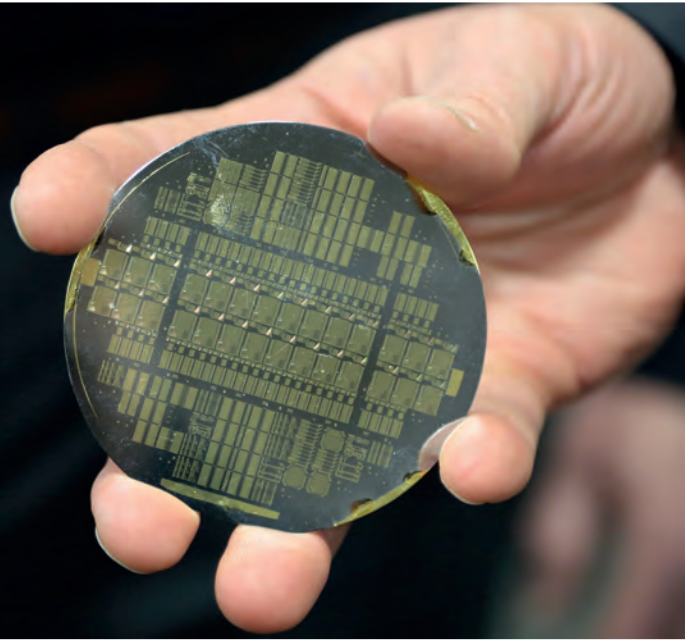

PIC ONLINE ROUNDTABLE

BASED around a hot industry topic for your company, this 60-minute recorded, moderated zoom roundtable would be a platform for debate and discussion.

MODERATED by an editor, this online event would include 3 speakers, with questions prepared and shared in advance.

THIS ONLINE EVENT would be publicised for 4 weeks pre and 4 weeks post through all our mediums and become a valuable educational asset for your company

Contact: jackie.cannon@angelbc.com



➤ Image of a biochip from Surfix Diagnostics, produced by LioniX International

How integrated photonics can bring testing to point of care

The world faces many healthcare challenges. Integrated Photonics is a new chip-like technology that has the promise to revolutionise diagnostics by integrating solutions that are small, scalable and affordable.

BY **PHOTONDELTA**

POST-PANDEMIC, healthcare providers around the globe face unprecedented challenges in providing timely, affordable, and efficient healthcare in order to improve the quality of care and patient outcomes in both developed and developing countries.

With an ageing population, it's been predicted by RIVM in the Netherlands that in order to keep up with the ever-growing demand for healthcare services, by 2050, 40% of the population will need to work in the sector.

The challenges facing healthcare today

In 2020, the World Health Organization (WHO) published a list of 13 urgent healthcare challenges for the next decade. The rising cost of healthcare in developed countries together with access to healthcare in developing countries are two major challenges to overcome in order to keep pace with global demand and make healthcare fairer. Discrepancies in healthcare quality not only exist between rich and poor countries, but between

different geographical regions within the same country. There are also environmental challenges to consider, such as access to clean water, and raising the profile of health within the context of climate change. This means global leaders need to improve air-quality and tackle climate change in order to reduce their negative impacts on our health.

Extreme weather events caused by climate change also have a direct consequence on our health, and can lead to malnutrition, the spread of infectious diseases, and global pandemics. If we learnt anything from COVID-19, it's that the world needs fast and effective solutions to halt the spread of viruses. But at the same time, with the global rise in less visible, non-communicable diseases (NCD), such as cancer and diabetes, we're also seeing an invisible epidemic which the WHO say adds up to 71% of the total annual death rate.

One way to address the gaps in patient outcomes is through more personalized healthcare. Why? It enables better treatment, which then leads to better patient care, but it also requires more effective diagnosis. In addition, preventative healthcare uses anticipatory measures to mitigate health problems before they arise. This includes things like education around healthy lifestyles to address issues such as obesity.

Clearly, something needs to be done now to meet the world's ever-changing healthcare needs. Action is needed throughout the care cycle, from healthy living and more effective diagnosis, to better patient monitoring during and post treatment. Tackling these challenges requires new approaches to healthcare, including the uptake of innovative and disruptive technologies to prevent, diagnose, and treat different medical conditions.

How integrated photonics can help

At the present time, specialized laboratories and hospitals perform highly specialized and complex testing. This process is not only expensive, it can also create bottlenecks within the healthcare system, causing delays in diagnosis and subsequent treatment. It's also not accessible to part of the world's population.

In principle, integrated photonics is able to improve diagnostic support by bringing sensing, imaging, and testing to frontline healthcare workers and their patients. Photonic chips, which are designed and fabricated like semiconductors, can provide small, lightweight, low-powered solutions ranging from fast and low-cost testing and preventative healthcare to patient monitoring and point of care (POC) diagnostics.

The use of integrated photonics enables medical device companies to develop increasingly reliable and sustainable solutions at scale, for a reduced cost, and using less energy.

Cutting the cost of healthcare

POC testing could help to cut healthcare costs and save time, by bringing reliable and accurate diagnostic devices to general practitioners (GP). In some cases, diagnostics, which could take 3 to 4 days in a centralized laboratory, could take 20 minutes with a local doctor. Based on the Worldbank's estimation of more than 9 million GPs worldwide, this is an incredible opportunity for healthcare professionals to deliver better, more timely care to their patients. It could even allow patients to perform certain tests at home. For medical device companies, there is also the appeal of a growing market. Grandview Research puts this value at \$36 billion USD in 2021, and that figure is set to double in size by 2028.

For doctors in developing countries, diagnostic tests might take months to complete, so having portable and relatively inexpensive diagnostic tools on the frontline can make a huge difference. Rapid testing currently has high visibility in applications such as glucose monitoring, haematology, pregnancy and fertility testing. At the same time, the recent pandemic has shown people the importance of POC testing, in the form of lateral flow and polymerase chain reaction (PCR) tests.

Integrated photonics opens up the possibility for similar applications in other areas of healthcare. As wearable devices, such as smartwatches, become ever smarter and more popular, they look certain to play a larger role in healthcare, with consumer tech and medtech starting to merge more deeply. Optical technology is already firmly embedded in existing wearable devices, so integrated photonics can play a key role in taking medical functionality and applications to the next level. For device manufacturers, Yole Development estimates that by

➤ Image of photonic chips with a biochip in the middle

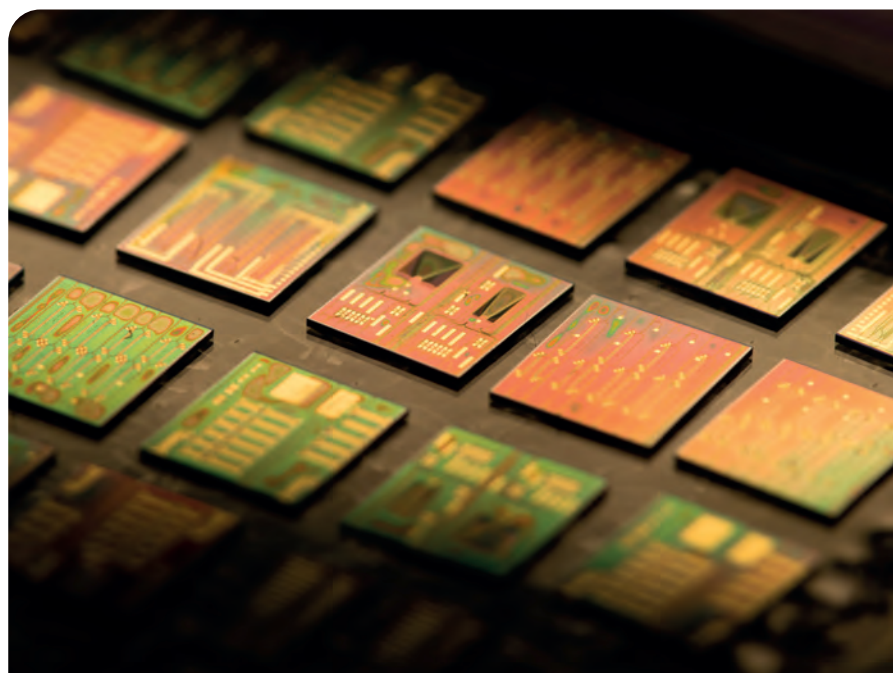

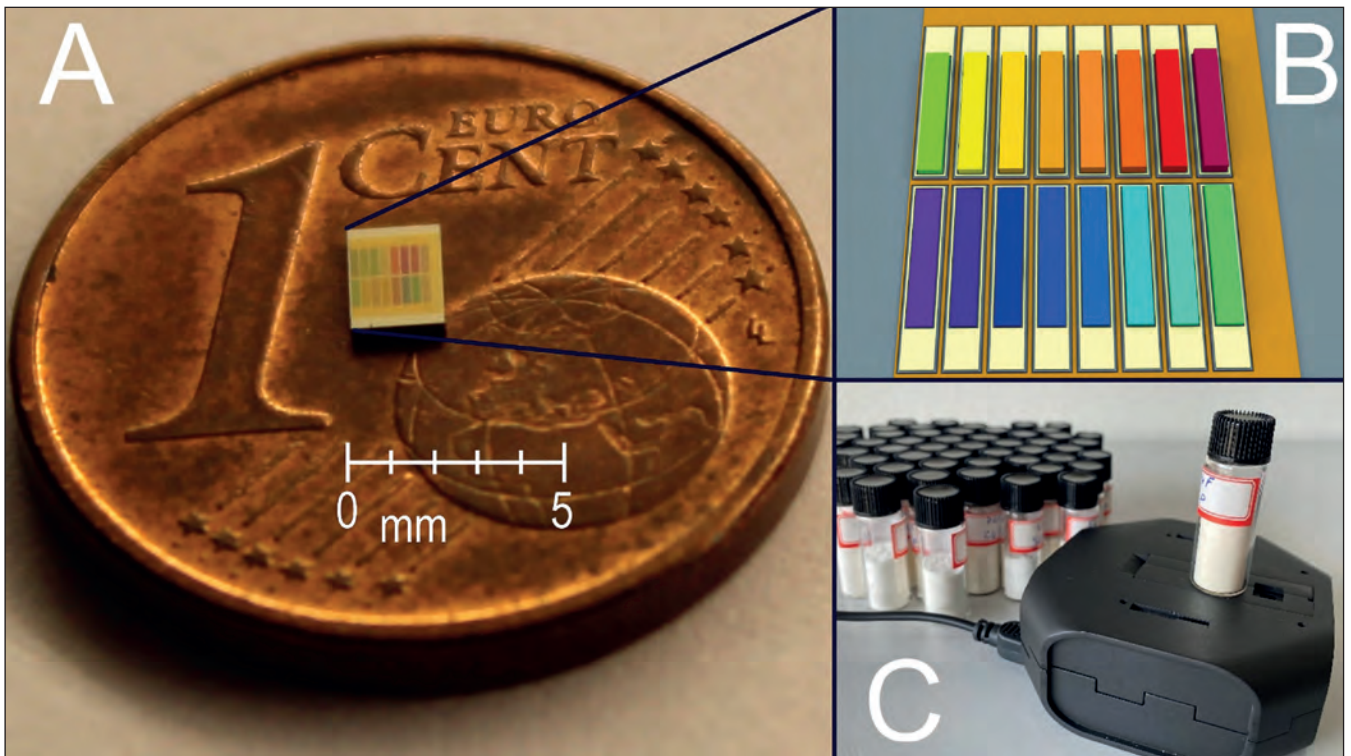

► Image of a near infrared spectral sensor from MantiSpectra that is used for the detection of e.g. illicit drugs

2028 the market size for wearables will have grown to over \$111 billion USD from just over 21 billion USD in 2021.

Alongside wearable technology, biosensors have an important part to play in the evolution of healthcare. PCR tests are one example of a commonly used biosensor. This technology has the potential to revolutionize healthcare by not only changing the way human health is managed and monitored, but by detecting and diagnosing diseases and microorganisms. Photonic biosensors offer fast, effective, disposable, and one-time-only tests.

Disruptive healthcare technologies

Sharing similarities with the manufacturing of semiconductor devices, integrated photonics enables developers to use tried and tested building blocks to create new and innovative solutions. This means that integrated photonics offers medical device companies the opportunity to develop highly scalable and cost-effective POC testing and

bring it to market faster. At the same time, the costs associated with improvements can be dramatically reduced. Here are six important photonic integrated circuit (PIC) platforms and their applications in POC testing:

Visible and near infrared spectroscopy

Used in smartwatches, visible and near infrared spectroscopy (NIRS) can measure vital signs such as heart rate, and biochemical markers including dehydration, and proteins.

In recent years, the exceptional growth of smartwatches and trackers shows the scaling and improvement potential for this type of technology. Initially, offering functionality related to sports and a more healthy lifestyle, wearables are beginning to lean into medical applications as well. By extending multispectral infrared spectroscopy using PICs, it's possible for wearables to monitor an array of biological information including levels of glucose, alcohol, and protein.

In recent years, the exceptional growth of smartwatches and trackers shows the scaling and improvement potential for this type of technology. Initially, offering functionality related to sports and a more healthy lifestyle, wearables are beginning to lean into medical applications as well

Raman spectroscopy

Well-known in testing laboratories, Raman spectroscopy is currently an expensive and complicated tool for measuring biochemical markers. However, when it comes to detection, Raman spectroscopy is the most accurate and specific solution. It has a variety of applications across multiple areas of medicine, ranging from breath analysis to bacteria typing.

Biochips

Photonic biosensors provide fast and effective rapid testing covering a range of functions from DNA and proteins to pollutants and contaminants. They can also be used to diagnose NCDs. Integrated photonic biochips are an ideal platform for POC testing because they are extremely sensitive detectors, which use ring resonators or Mach-Zehnder interferometer chips. They can detect multiple diseases, infections, or viruses, such as COVID-19, as well illnesses such as cancer using various biomarker layers. Easy to scale, they offer low-cost potential when produced in larger volumes.

Optical Coherence Tomography (OCT)

Currently used across a range of medical areas, including ophthalmology, oncology, and cardiology, Optical Coherence Tomography (OCT) has the potential to improve early detection, particularly in hard-to-diagnose illnesses such as bladder cancer.

Commonly found in large laboratory instruments with discrete optical components, OCT integrations also enable developers to create smaller, low-cost instruments for new applications. Two existing approaches are in use and highly suited for PICs: Spectral Domain uses a broadband light source and a spectrometer; Swept Source uses a tuneable laser.

Optoacoustic, photoacoustic, and fully optical ultrasound

Already used for a number of medical applications, these platforms essentially put a laser beam through soft tissue. As the laser hits the tissue in short pulses, it creates thermal expansion and relaxation, which can be measured as ultrasound waves. This optical sound can be detected and used to create an image of the soft tissue. Using integrated photonic microphones enables very sensitive ultrasound arrays. With broad applications in soft tissue imagining, such as proton therapy, in certain circumstances it could even replace MRI scanners.

Fibre Bragg grating sensing

This special type of fibre, which uses light to detect vital signs, has applications in all kinds of patient

monitoring such as temperature, pressure, strain, and vibration. The specially prepared fibre is non-conductive and immune to electric and magnetic fields (MRI sensing). Detecting the wavelength shift of reflected light under temperature or pressure change, it is extremely accurate. Applications can be found in catheters (haptic feedback), patient monitoring, and shape sensing. It can also be used in diagnostic and interventional cardiology to detect heart failure.

Future opportunities

Without question, integrated photonics has the potential to revolutionize the healthcare industry by helping it to overcome some of the toughest, global challenges. As a technology, integrated photonics, provides the opportunity for volume scaling, miniaturization, and low-cost manufacturing of POC medical devices which provide faster diagnostics, and preventive insights.

As we've seen, six diagnostic platforms have the potential to serve multiple applications, and each time a new tried and tested

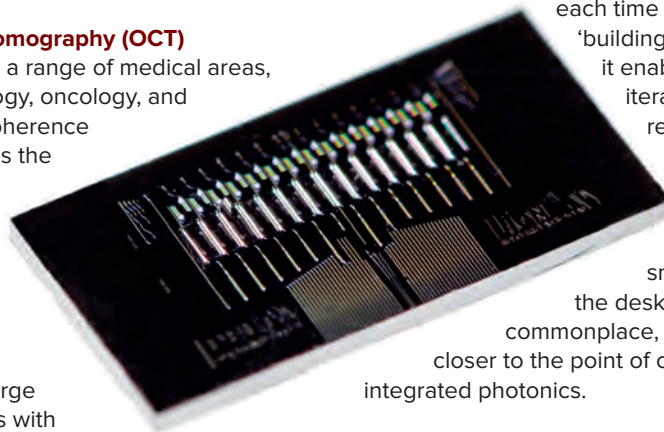

'building block' is added, it enables developers to iterate faster – ultimately, reducing the time to market for new medical devices.

Soon, devices small enough to sit on the desk of a GP will become commonplace, as testing moves ever closer to the point of care, with the help of integrated photonics.

These accurate smaller, and more accessible devices will provide long term value for money, and being to empower GP's, with the kind of diagnostic capabilities previously only available to expensive laboratories or specialist hospital departments. Frontline diagnostics, whether in a hospital or out in the field, can then enable medical practitioners to quickly escalate patients who need expert care, and drastically reduce the patient timeline from diagnosis through to recovery.

Innovative medical device companies, leveraging the potential of integrated photonics, need a full value chain, including supporting analysis software and tools. PhotonDelta is a ready-made and steadily growing public-private partnership providing an end-to-end supply chain and a community of innovative enterprises and manufacturers of photonics technology.

The PhotonDelta growth fund supports platform and value chain developments within the integrated photonics industry. Find out more by downloading PhotonDelta's roadmap for Integrated Photonics for Biosensing 2021.

➤ Image of a biochip from Delta Diagnostics, produced by Lionix International

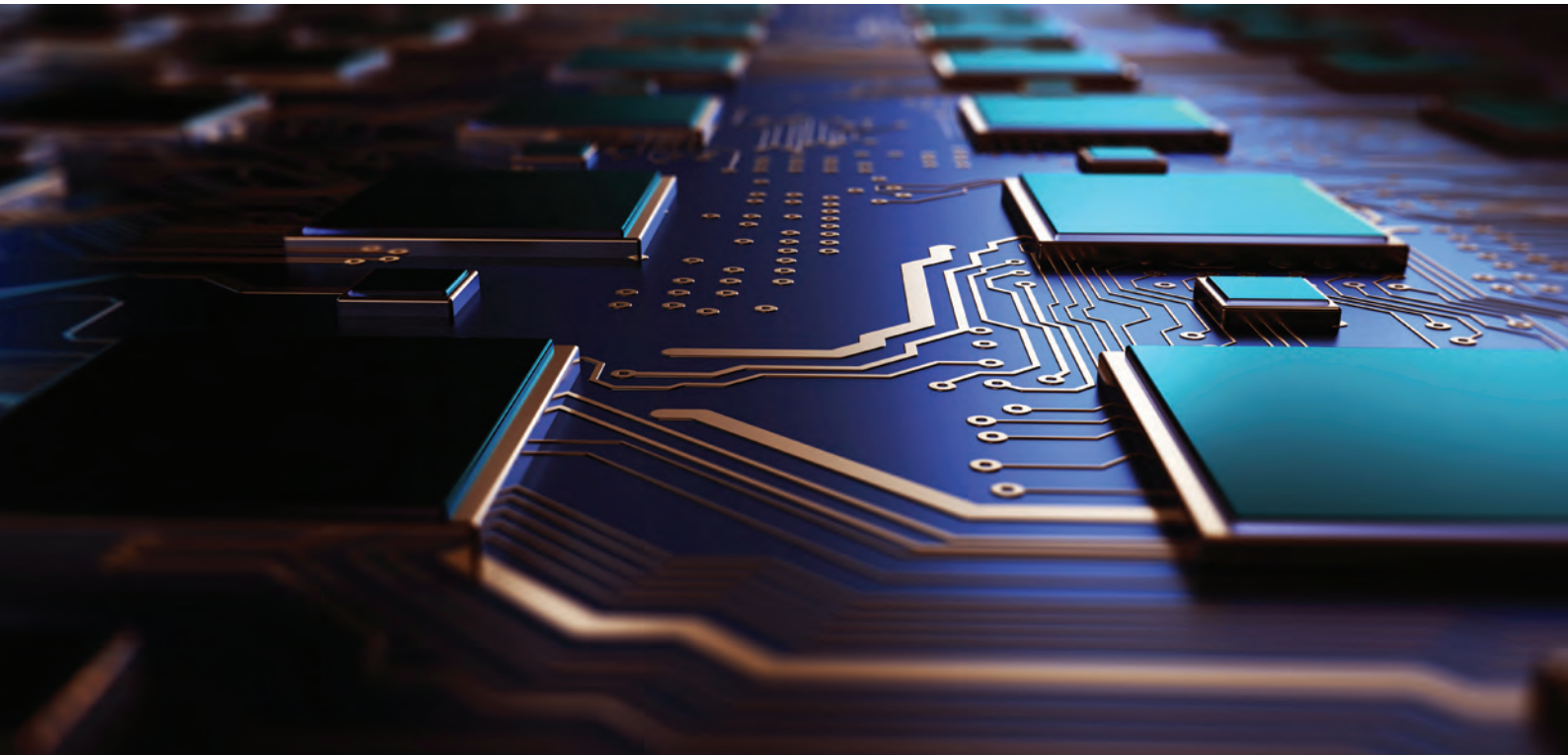

Modeling silicon photonics process parameter variations in Synopsys OptoCompiler-OptSim

The estimation of yield and optimization of photonic integrated circuit (PIC) design require ability to accurately account for variations in the SiPh technological parameters.

BY JIGESH K. PATEL, TECHNICAL MARKETING MANAGER, CUSTOM DESIGN AND MANUFACTURING GROUP - **SYNOPSYS**

SILICON PHOTONICS (SiPh) refers to the enablement of photonic integrated circuits (PIC) over silicon wafer. SiPh enables compatibility with existing CMOS manufacturing infrastructure for large-scale integration and brings the associated benefits to the photonics, namely, lower footprint, lower thermal effects, and co-packaging of electronics and photonics on the same chip.

One of the side-effects of nanometer regime scaling in modern semiconductor technologies is that the impact of local (i.e., within die) variations has increased; and, efforts to reduce manufacturing variations can impose capital-intensive penalties. With the process nodes becoming smaller, corner design approaches, typically used in digital (electronic) designs, alone are not sufficient. This

is especially true for the photonic designs which are more analog-like. As a result, PIC designers are tasked with the inclusion of stochastic nature of process variations into their design process and finding ways of minimizing the impact.

In this blog, we describe how process parameter variations can be included as part of the electronic-photonic design automation (EPDA) in Synopsys OptoCompiler-OptSim. The organization of the article is as follows. We begin by a high-level classification of process variations. Next, we describe two of the approaches electronic-photonic circuit simulations can account for Monte Carlo process parameter variations during the design stage. Two case studies are presented as illustrations of each approach.

Classifying behavior of the process parameter variations

One of the ways of classifying variations in process parameters is based on the spatial scope of their influence [1-2]. Figure 1 shows types and scope of the process variations of interest.

The deterministic variations are systematic contributions from the same steps in the manufacturing process. Some of these variations can be corrected to most extent, for example, optical proximity corrections (OPC) in photolithography.

The random variations are a result of varying number of causes during the manufacturing process. Variations that affect all devices on the chip the same way are considered global. Variations from fab-to-fab, lot-to-lot, wafer-to-wafer and die-to-die (D2D) all contribute to the global variations.

The within-die (WID) variations are local to the chip and can be purely random (i.e., independent) or spatially correlated (i.e., location dependent). Typically, these local variations contribute the most to the overall process variations.

Summarizing the above, process parameter variations in a parameter α can be modeled as:

$$\alpha = \alpha_0 + \alpha_{D2D} + \alpha_{WID, random} + \alpha_{WID, correlated}$$

where α_0 is the nominal value of the parameter α . Last three terms in the above expression represent die-to-die and within-die variations.

The mean and variance of α are:

Mean:

$$m_\alpha = \alpha_0$$

Variance:

$$\sigma_\alpha^2 = \sigma_{\alpha D2D}^2 + \sigma_{\alpha WID, random}^2 + \sigma_{\alpha WID, correlated}^2$$

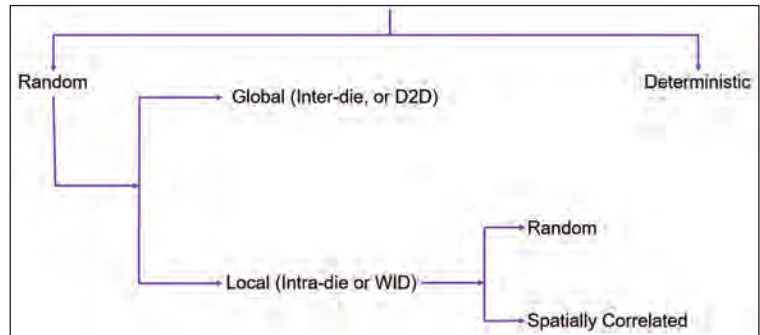

► Figure. 1: Independent and Correlated Process Parameter Variations in Silicon Photonics

Next, we illustrate two of the ways a designer can account for above variations in Synopsys OptoCompiler-OptSim EPDA design flow.

Monte Carlo process variation and corner analyses in Synopsys OptoCompiler-OptSim

The process parameter variations can be incorporated in OptoCompiler-OptSim during simulation either via parameter definitions in a PrimeWave testbench or via sub-circuit instances of the model with process variations.

Defining parameters using statistical expressions

As an example of the former, let's consider a 6-stage lattice filter design of Fig. 2. Each of the two hierarchies of Fig. 2(a) is implemented as a 3-stage filter. In this example, the gap G between the straight and curved waveguide, and width D of the delay element (Fig. 2(c)) are defined in the PrimeWave testbench.

Defining parameter G via a statistical expression, say, GAUSS(1 μ m,0.025 μ m) would imply that gap G follows a Gaussian distribution with 1 μ m mean

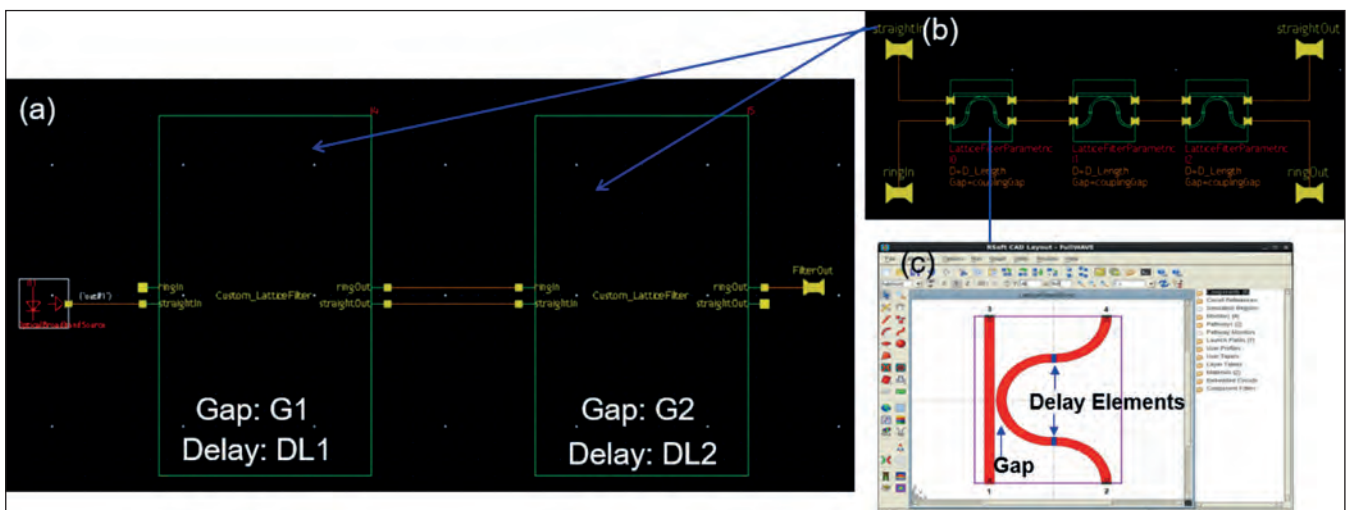

► Figure. 2: Schematic of a 6-stage lattice filter (a). Each hierarchy comprises of three stages (b) where each stage is implemented as parametric custom photonic block (c)

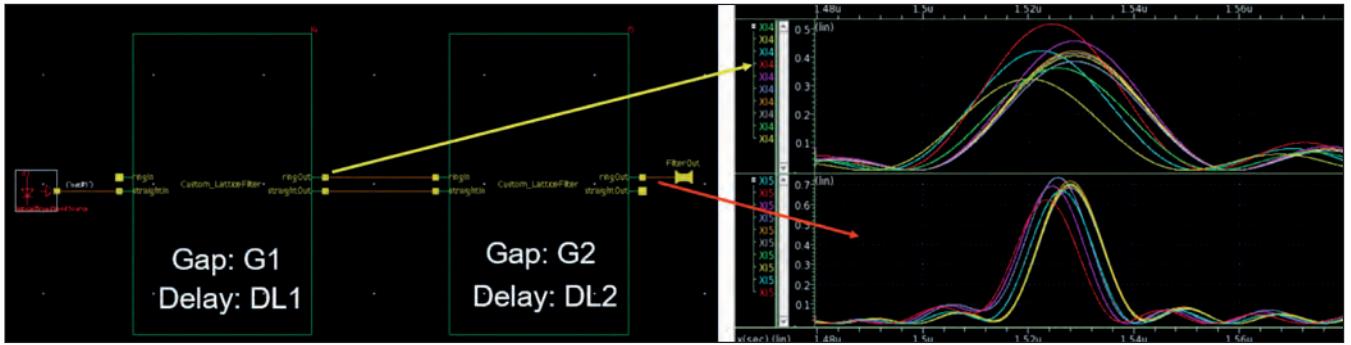

► Figure 3: Filter response after 3- (upper right) and 6- (lower right) stages of lattice filters accounting for process parameter variations in gap and delay length

```

Sub-circuit (netlist) filename
statmodel_parametricWG.sp - Notepad
File Edit Format View Help
$ OptSim Circuit Netlist
Sub-circuit name
.subckt wguide W H parametric subCkt in out length=50 height=0.22
.PARAM mc width=AGAUSS(0.5,0.025)
X1 in out wguide W H parametric length=length width=mc_width height=height $ location=(0,0) libName=customPDK parametric
.ends wguide_W_H_parametric_subckt
Model name
Library name from where model is called
    
```

► Figure 4: Example of a sub-circuit definition with process parameter variations

and a 3σ deviation of $0.025\mu\text{m}$ relative to the mean. Process correlation can be specified via intermediate variable definitions.

For example: $G1 = \text{GAUSS}(0.1\mu\text{m}, 0.025\mu\text{m})$

$G_Correlated = G1$

$G_wafer_to_wafer = \text{AGAUSS}(0.0, 0.01\mu\text{m})$

With the above definition, all the model instances that use parameters G1 or G2 will carry independent random values. On the other hand, G_Correlated will be evaluated once and the same value will be carried over to all occurrences of variable G_Correlated. If G_wafer_to_wafer represents another random variable with zero mean and absolute 3σ deviation of $0.01\mu\text{m}$, an expression like $G2 = G1 + G_Correlated + G_wafer_to_wafer$ would account for local and global random variations in design parameter gap of the second hierarchy of Fig.2(a). Figure 3 shows results of a Monte Carlo simulation run with correlated statistics for filter design parameters gap and delay length.

The plots show deviations in the filter response after 3- and 6-stages due to process parameter variations.

Using sub-circuit definitions

Another way of including process parameter variations is using sub-circuit definitions for the devices used in a PIC. A sub-circuit defines statistics

for the model parameters of interest. An example of a sub-circuit for a waveguide model with Monte Carlo variations in its width is shown in Fig. 4. Conceptually, a sub-circuit is like a design hierarchy where statistics are passed from the outer hierarchy to the model inside the hierarchy.

A collection of such sub-circuits can serve as a library of components with process parameters that can be shared with design partners or can be used as models during schematic creation in OptoCompiler, an example of the latter is illustrated in Fig. 5.

As shown in Fig. 5(a), a broadband source shines light on a Mach-Zehnder Interferometer (MZI) implemented using two sub-circuits of a parametric waveguide. The waveguide width incorporates Monte Carlo variations due to manufacturing processes.

As shown in Fig. 5(b), the sub-circuit netlist file is included in the simulation via PrimeWave's Setup → Include Files option of OptoCompiler. Figure 5(c) shows effect of process variations in the MZI response at the constructive and destructive interference ports.

Summary

The estimation of yield and optimization of photonic integrated circuit (PIC) design require ability to accurately account for variations in the SiPh

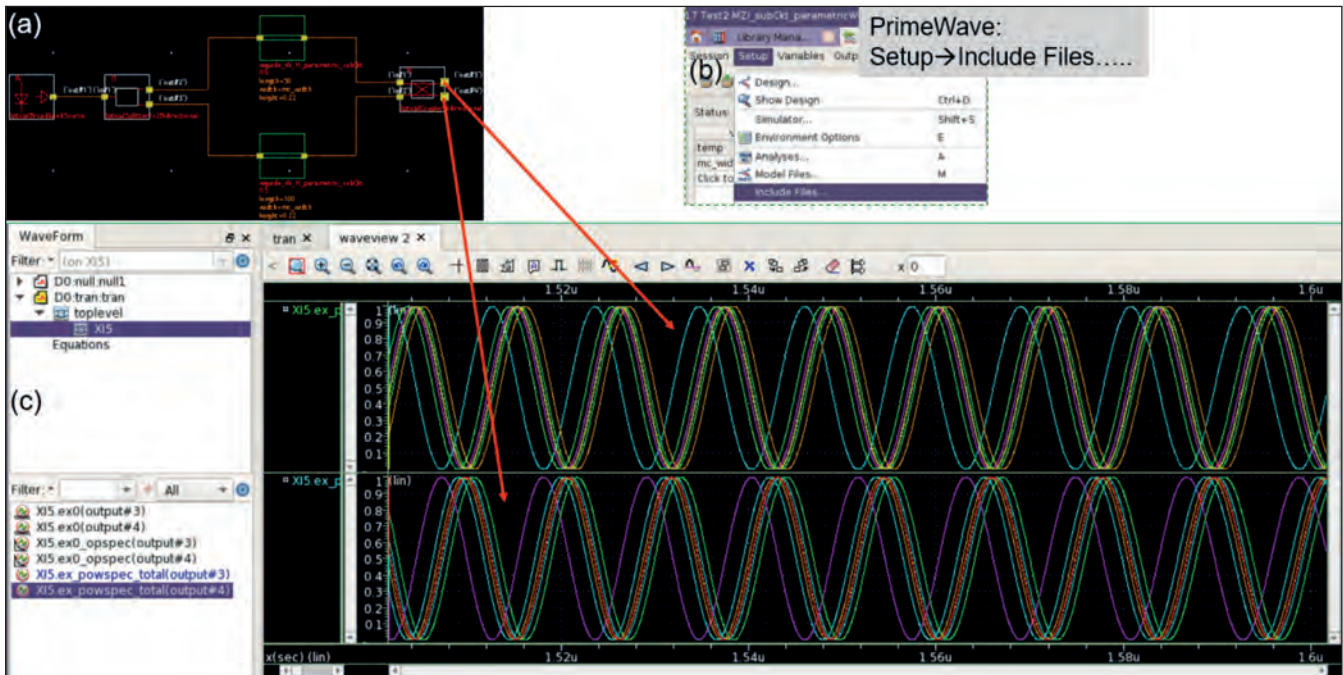

► Figure 5: (a) A Mach-Zehnder Interferometer (MZI) comprising of two waveguide sub-circuits (b) including sub-circuit file of Fig. 4 during run time and (c) MZI response due to process parameter variations

technological parameters. These variations can be systematic (i.e., deterministic) or non-systematic (i.e., random).

The spatial scales of variations include die-to-die (or global) variations, and intra-die (or local) variations. The intra-die variations can further be divided into spatially correlated and independent variations.

The Synopsys EPDA offers powerful, EDA-like Monte Carlo and corner analyses to account for all these variations within OptoCompiler-OptSim environment making design experience closer to the traditional CMOS chip design.

ACKNOWLEDGEMENTS & REFERENCES

► Acknowledgement

The author is grateful to his colleagues Dr. Pablo Mena, Twan Korthorst, Dr. Dwight Richards, and Enrico Ghillino for technical discussions and help during preparation of this article.

References

- [1] Blaauw, D., Chopra, K., Srivastava, A., "Statistical timing analysis: From basic principles to state-of-the-art," IEEE Trans. CAD ICS, vol. 27, no. 4, 2008, pp. 589-607
- [2] Champac, V., Gervacio, J. G., Timing performance of nano-meter digital circuit under process variations, Springer, 2018.



Talk to us about sponsorship **NOW**
as it will be another full house

Contact us at: info@angel-tech.net

Or call us on +44 (0)2476 718970 and speak to
Sukhi Bhadal or **Stephen Whitehurst**

SAVE THE DATE

18-19

APRIL 2023

**SHERATON BRUSSELS
AIRPORT HOTEL BELGIUM**

How a hybrid integration platform for co-packaged photonics solves many of the chip industry's problems

When industry leaders gathered in San Diego for the 2022 Optical Fiber Communication Conference, several of them reacted with amazement and even disbelief when they witnessed demonstrations of the POET Optical Interposer. What impressed the industry in March, and in the months since, is the elegance of the engineering that has led to the development of the innovation's differentiating features.

BY POET TECHNOLOGIES

THE UNIQUE hybrid integration platform of the Poet Optical Interposer uses a CMOS-based Optical Interposer for wafer-scale passive assembly of electronics and photonics devices. It does it with a minuscule form factor and a reduction of the bill of materials that represents a drop in assembly costs from as much as 70% of total cost to less than 20%.

The versatile platform includes all the features necessary for high-speed datacenter applications: excellent RF performance, low loss, athermal and non-birefringent waveguides and low loss chip-to-fiber coupling, passive placement of optical devices, excellent thermal properties with low thermal resistance, and low-cost wafer-scale assembly and

test. Products based on the Optical Interposer show excellent performance for 100G, 200G and 400G applications, and are readily scalable to 800G and 1.6T pluggables.

The development of the underlying technology and products based on the Optical Interposer was completed in about five years by the POET team in consultation with executive leaders in semiconductors, telecommunications, optoelectronics and datacenter management.

With the desire for faster, more reliable transfer of data to satisfy our hyperconnected world, the networking industry has been stressed to meet

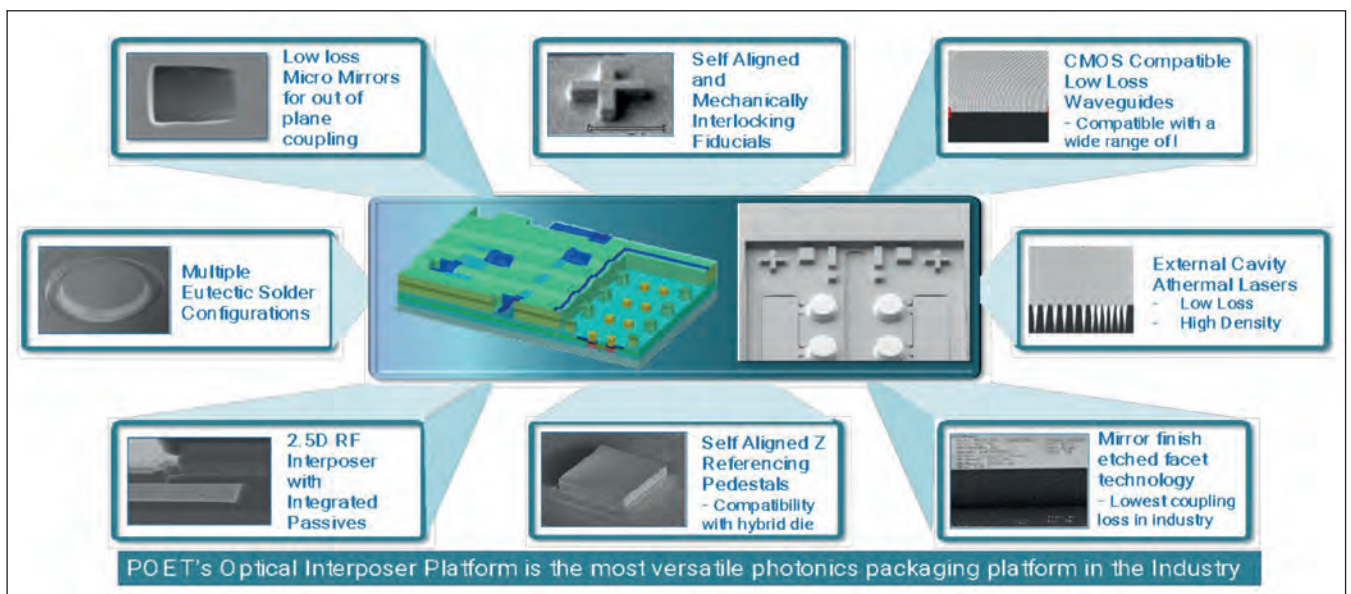

➤ POET Technologies has built a proprietary Optical Interposer that impressively reduces cost and the bill of materials.

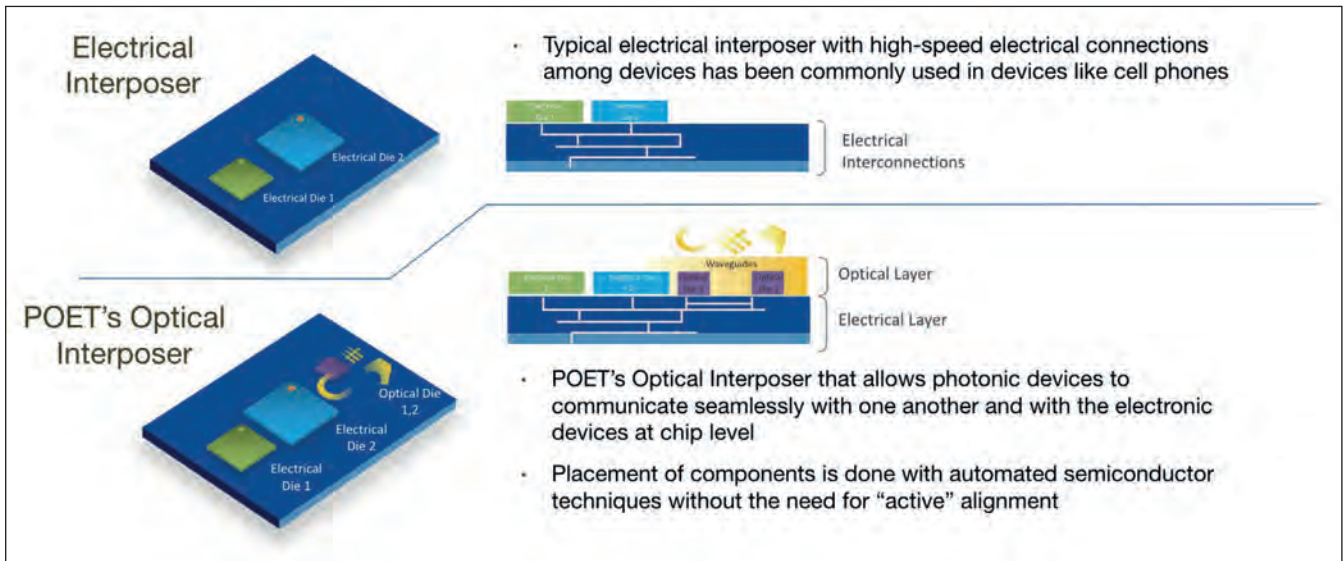

the demand. Delivering dependable service with conventional technology has been a challenge. A need for a better solution exists and results indicate the Optical Interposer is in the lead to meet that challenge.

The Optical Interposer's distinct features

The Optical Interposer is constructed using CMOS-compatible wafer fabrication methods using a high-resistivity silicon substrate to enable high-speed RF communications. Electrical traces required for electronic component interconnectivity are first formed on the silicon substrate. Integrated heat sinks are incorporated under the metal and in regions of the interposer that house the lasers, enabling a low thermal resistance for the lasers, which is critical to ensure laser functionality in uncooled applications.

Thereafter, multiple waveguide layers are monolithically deposited on the wafer. These waveguides are configured to perform the various passive optical functions required such as multiplexers, de-multiplexers, vertical and in-plane couplers, interferometers and directional coupler-based power taps. The Optical Interposer is then finished with low-loss vertical coupling mirrors for out-of-plane optical connections and with mirror-like etched facets for in-plane coupling of lasers and fiber connections.

Self-referencing pedestals, fiducial marks and mechanical guides enable visually assisted passive placement of the optical devices integrated on the platform. Finally, eutectic solder is deposited on the interposer to promote flip-chip bonding of the optical and electrical components that are subsequently assembled on the platform.

Along with the passive alignment of lasers for flip-chip bonding, the approach enables straightforward integration of photonic elements such as detectors.

Here are details of the primary components within the Optical Interposer that help it to bring novel solutions to market.

Waveguides: POET's waveguides are designed to both be CMOS compatible and provide low-loss characteristics. The material loss through the waveguides characterized by prism spectroscopy is less than 0.3dB/cm and is about one order of magnitude better than typically observed in small core silicon waveguides used in most other silicon photonics technologies. Moreover, the waveguides are largely athermal ($dn/dT=12\text{pm}/^\circ\text{C}$) and are non-birefringent. A proprietary spot-size converter has been designed for chip facet fiber coupling and it achieves facet coupling losses of 0.25dB.

The addition of these patented waveguide layers on a conventional semiconductor wafer is critical to enabling the integration of electronics and photonics components at wafer scale.

➤ POET Technologies' Optical Interposer sandwiches optical layers between two electrical layers to create next-generation chip solutions.

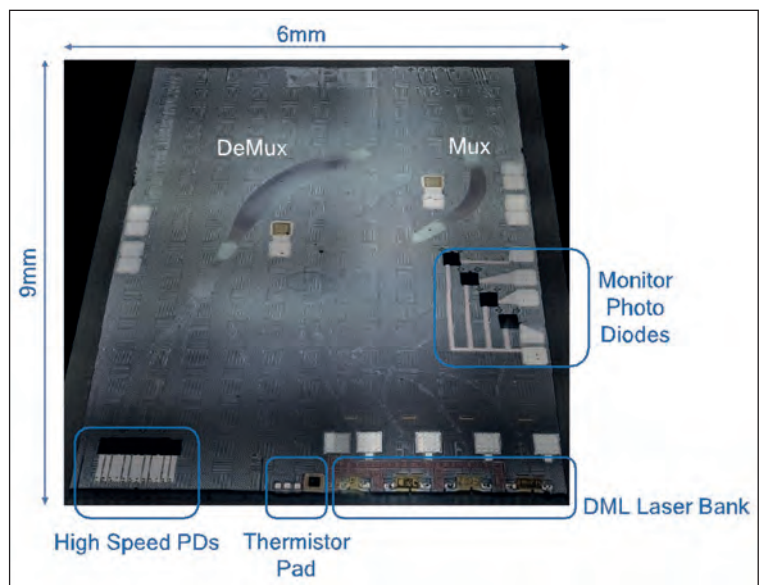

➤ The miniature form factor of the Optical Interposer makes POET's device attractive for manufacturers.

➤ The waveguides are key to the lasers within the Optical Interposer, which can include inexpensive DMLs.



- POET's Interposer platform includes proprietary features for laser attach
- Laser – waveguide coupling performance excellent for both CW and DML lasers
- Passive laser placement and wafer scale assembly

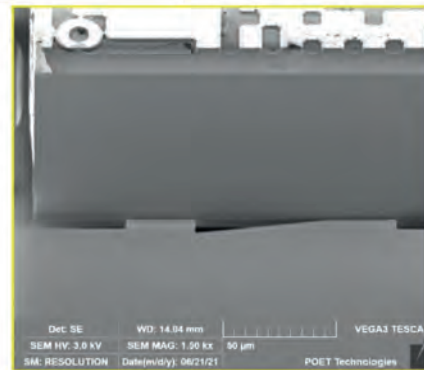
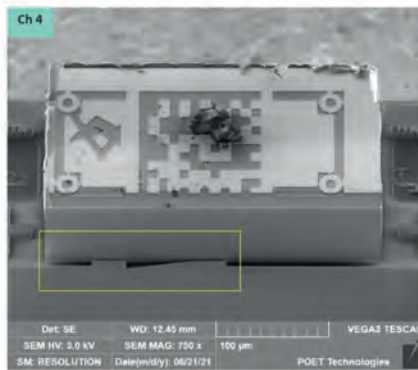

Optical passive device performance: Waveguides must be designed and configured into high-performance optical passive devices for use in any optical application. Multiplexers and demultiplexers form the backbone of any direct detect data-communications wavelength division multiplexing (WDM) system. These devices have to be precisely engineered for the required bandwidth spectrum used (for example, FR4 or LR4). The measured optical spectrum for the passive demux/mux devices built on the Optical Interposer for FR4 and LR4 systems offer excellent insertion loss, crosstalk and channel uniformity. These are achieved while exceeding industry requirements.

for wafer-level testing. When coupled to a PD, the vertical mirrors deliver a 0.5dB coupling loss, an outstanding result compared to competing solutions.

Thermal Performance: Achieving low thermal resistance is a critical requirement for hybrid integration. The Optical Interposer has consistently shown that it can achieve equivalent thermal resistances to conventional P-up lasers, which are mounted on a standard AlN submount. With the Optical Interposer, a P-down laser is attached to attain a comparable thermal path from the heat source (laser) to the back of the device through the integrated heat sink.

Vertical Mirrors: In addition to in-plane coupling of light, POET's Optical Interposer utilizes vertical mirrors to enable out-of-plane coupling. The vertical mirrors are used with top-entry photodetectors and

Laser Coupling: One of the key benefits to using the Optical Interposer is its visually assisted wafer-scale passive placement of optical devices such as lasers while simultaneously achieving good

➤ The POET Optical Interposer is an elegant solution that is scheduled for commercial deployment in 100G, 200G and 400G applications.



coupling efficiency to the waveguides. The coupling performance for CW lasers with integrated spot-size converters is best in class for such passive alignment techniques. A coupling efficiency of 90% (1dB) has been achieved using the Optical Interposer.

Product Demonstration: The features of the Optical Interposer have been used along with compatible optical components to create the world's smallest single-chip optical engine for 100G and 200G applications. At 6mm x 9mm, the POET optical engine incorporates four lasers, four high-speed photodetectors, four monitor photo diodes and a multiplexer/de-multiplexer pair.

The optical engine is so small, that a transceiver module manufacturer can fit four such engines inside a standard QSFP-DD module, thus quadrupling data rates for a given faceplate density. The Optical Interposer also achieves excellent eye margins, and 100G and 200G receivers built using this technology have demonstrated outstanding characteristics, meeting 10km LR4 system requirements based on BER/sensitivity performance.

With clear advantages in cost and scale, it is little wonder that the tiny Optical Interposer has garnered significant interest from the optoelectronics community and beyond. Among the interesting partnering opportunities that have emerged are those with innovative device companies that are seeking to utilize POET's platform to usher in a new era of optical engines for transceivers and co-packaging applications. POET has partnered with Celestial AI, a Silicon Valley-based developer of artificial intelligence and machine learning solutions, and is preparing to deliver samples of a packaged light source assembly for AI-ML accelerator chips.

In addition, the POET team has had dozens of conversations with heads of leading companies in a variety of industries since its live product demonstrations at the OFC Conference. With engineering teams in Singapore and two locations in China (Shenzhen and at the joint venture, Super Photonics, in Xiamen), POET is able to work with partners to customize solutions and maximize the capabilities of its platform technology. In June, POET became a founding partner of the Singapore Hybrid-Integrated Next Generation μ -Electronics (SHINE) Centre, located in the College of Design and Engineering at the National University of Singapore (NUS), where research and development teams will work to unlock hybrid-integration solutions for the industry. POET's participation as a founding member gives it access to a variety of advanced packaging tools and engineers, as well as opportunities to showcase its technology and collaborate with a global industrial and academic network of companies and universities.

The current and future solutions built from the Optical Interposer are poised to drive the next

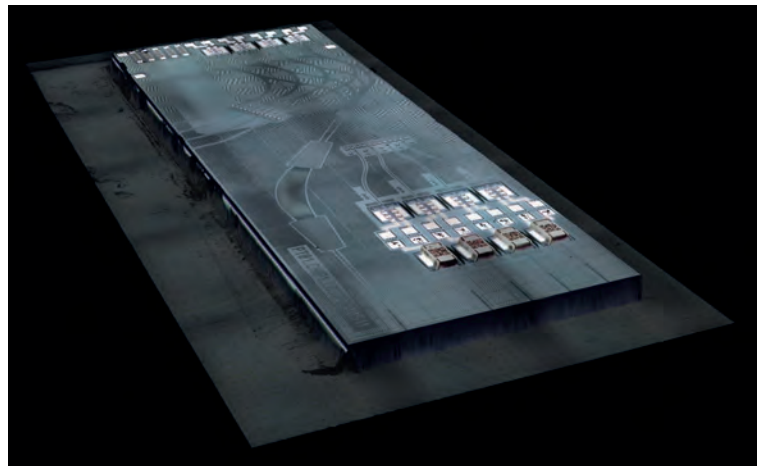

generation of microelectronics engineering, beginning with an exciting fall when the first commercial products using the device enter production at Super Photonics, which benefits from Xiamen Sanan Integrated Circuit's world-class facility and a growing engineering team. Because it is an integration platform that is agnostic to the material system, the Optical Interposer provides great flexibility to engineers and manufacturers, allowing it to penetrate multiple markets. This distinctive feature means that POET can address applications where conventional free-space optics or traditional silicon photonics cannot. The pieces are in place for POET to deliver on the promise of the Optical Interposer and the industry has taken notice.

As one executive of a peer company at OFC 2022 marveled when seeing the form factor of the Optical Interposer: "Well, you can't get much smaller than this." You can't — and that innovation of saving space without sacrificing performance is why the platform is such a big deal.

➤ Assembly of products that feature the POET Optical Interposer takes place at a state-of-the-art facility in Xiamen, China.

With clear advantages in cost and scale, it is little wonder that the tiny Optical Interposer has garnered significant interest from the optoelectronics community and beyond. Among the interesting partnering opportunities that have emerged are those with innovative device companies that are seeking to utilize POET's platform to usher in a new era of optical engines for transceivers and co-packaging applications

The Role of PICs in the Data Communications Roadmap

As bandwidth consumption continues its meteoric rise, the complexity of optical links and the transceivers within them continue to increase in complexity. Yet at the same time, data center operators are demanding more efficiency. Current discrete optical subassemblies can no longer meet future transceiver requirements. The time has come for PICs to deliver on their promise and save the future of optical transceivers. In this article, the role of PICs in future optical transceivers is examined.

BY JIM THEODORAS, **HG GENUINE**

A QUICK PERUSE of the leading optical industry news sources reveals that Photonic Integrated Circuits (PICs) continue to be an area of substantial hype and investment. Given the global impact of silicon integrated circuits, it is no surprise that the optical industry has spent decades trying to replicate the success. PIC categories, types, and technologies are as widely varied and numerous as the color swatches at a paint store. A more recent area of focus is the use of PICs in optical

communications, as they hold the promise of breaking the bandwidth logjam that is rapidly building up with traditional techniques.

Bandwidth consumption is outpacing the pace at which the optical communication industry can respond. Three ways of increasing an optical channel's throughput is to simply go faster (increase bits per second), go wider (increase the number channels), or get smarter (more complicated modulations than just on/off). The industry has done an admirable job of increasing laser modulation

speeds over the decades, but more recently speeds cannot keep up with needs. The industry recently made the difficult jump to PAM4 modulation, which doubled throughputs, helping with the inability of speed to scale fast enough. But even faster lasers and higher order modulations have not been enough, and so the number of channels in each link continues to climb. Looking at standard Ethernet, the physical link definitions have grown from one to four to eight lanes, with 16 lanes on the horizon.

The aforementioned bandwidth logjam is created by conflicting market river currents. While the complexity and number of channels of optical communication links increases, the end customers who are buying and hence funding this growth



are demanding greater efficiency in power, price, and space. For example, one popular 800G optical transceiver is a 2x400G-FR4 in OSFP and QSFP-DD form factors. This product contains two sets of 4 colors of 100G, each channel having a laser, modulator, collimation lens, and a shared wavelength multiplexer on the transmit side alone. Producing an optical transceiver with this high of a component count is certainly doable, but it is doubtful continuing down this path will yield the longer term efficiency gains end customers are looking for. The excitement, work, and investment in PICs is an effort by the industry to break through this barrier.

So if PICs are the answer, what should a PIC look like for use in an optical communications link, and more specifically a pluggable transceiver? Optical transceivers consist of a wide range of mechanical, electrical, and optical componentry. These parts need to be grouped together by the most appropriate technology. For example, the host PCB can contain the paddle card connector, microcontroller, power supplies, memory, and serve as a mounting point for the metal clamshell housing. The key problem is what functions should a PIC replace, and the answer depends on the PIC technology being used. In traditional optical transceivers, the optical subassemblies are referred to as the Transmitter Optical Subassembly (TOSA) and the Receiver Optical Subassembly (ROSA), or sometimes combined as a TROSA. Generally speaking, the goal of PICs is to replace the TOSA, ROSA, or both in the TROSA.

One common mistake is to estimate a market value of a PIC replacement on the total costs of the subcomponents that it is replacing. For example, if a PIC replaces a laser, modulator and wavelength multiplexer, then the PIC's market value is the sum of the laser+modulator+mux cost. While this seems reasonable, the logic is flawed, in that the

Rate	Speed	Mod	Number
10GE	10	NRZ	1
40GE	10	NRZ	1
100GE	25	NRZ	4
	50	PAM4	1
200GE	25	PAM4	4
400GE	50	PAM4	4
800GE	50	PAM4	8
	100	PAMx	8
1.6TE	50	PAM4	16
	100	PAMx	8
3.2TE	100	PAMx	16

true market value of a PIC could be higher or lower than the sum of the costs. In order to understand why, the economic lifecycle of transceivers must be considered.

There are three phases to the pricing of a transceiver. Early in its lifetime, say the first 6 months, market pricing dominates. The price of the transceiver is basically whatever the market will bear, ranging from free samples to heavily marked up alpha prototypes. The next phase is a transceiver's economic lifecycle is the BOM phase, where the Bill of Material costs dominate as the transceiver is priced BOM plus margin. This is often where aggressive price concessions are demanded by end customers and hence the BOM changes

➤ As Datacom has struggled to keep pace with bandwidth demand, Ethernet links have not only become faster, but wider as well.

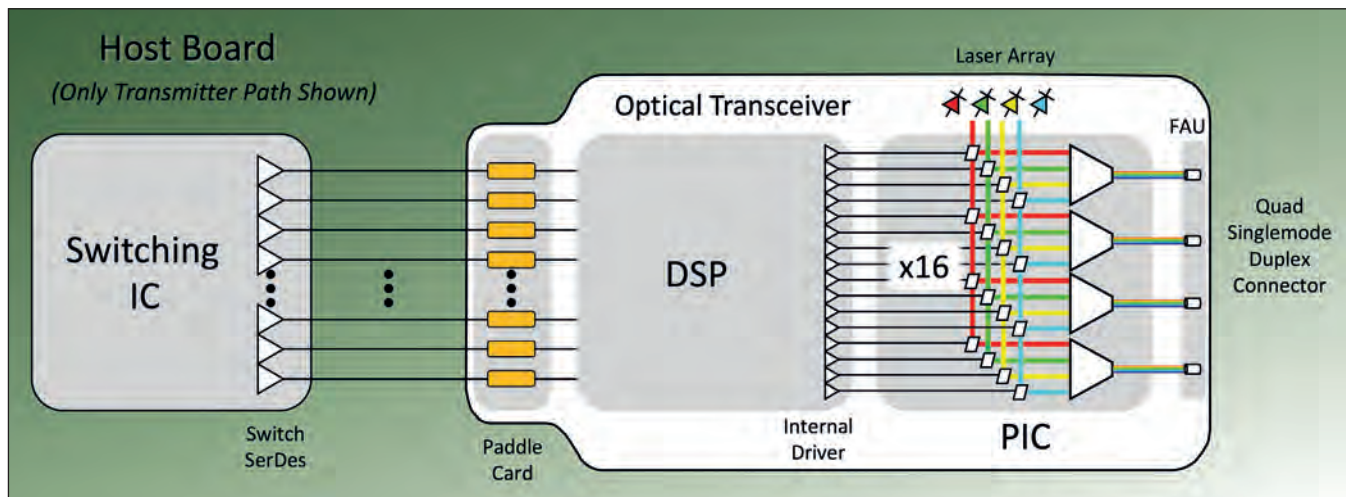

➤ The ideal optical transceiver would consist of just a DSP and PIC. This 4xFR4 example shows 4:1 color laser sharing enabled by Photonic integration.

frequently and Product Change Notifications PCNs are issued as part of cost reduction efforts. The third and final phase is the longest, as well as where most of the revenue and profit is made on an optical transceiver. In this last phase, manufacturing costs dominate. The amortization costs of all the machinery inherent in modern factories greatly exceeds the BOM costs which have by now stabilized. And it is in this manufacturing dominated stage that PICs offer the greatest potential value. By requiring fewer manufacturing steps, less equipment, or even just enabling a faster production rate, PICs can be game changing.

colored lasers, modulators, wavelength multiplexer/demultiplexer, need no isolator, have integrated photodiodes and transimpedance amplifiers, and be compatible with the same solder reflow process as the DSP package. At the time of this writing, no PIC technology yet exists that delivers all of these functions, but several promising technologies are very close.

Assuming the perfect PIC did exist, what might a transceiver look like? A popular optical transceiver variant used in Hyperscale data centers today is known as a FR4, which uses 4 color channels at 100Gb/s each to deliver 400Gb/s aggregate bandwidth up to 2km. To fully leverage the density advantage of a PIC, 4 of these FR4 could be shoehorned into single transceiver, thus maximizing the sharing of not only common functions, but potentially 4:1 laser sharing as well. Ideally, the DSP and PIC would be the only major integrated elements, and both could be flip-chipped onto a single substrate. That electrical/optical substrate would then be mounted on the PCB that would provide the paddlecard edge connector, power supplies and microcontroller.

Assuming the perfect PIC did exist, what might a transceiver look like? A popular optical transceiver variant used in Hyperscale data centers today is known as a FR4, which uses 4 color channels at 100Gb/s each to deliver 400Gb/s aggregate bandwidth up to 2km

Given this new perspective, PICs destined for optical transceivers must be evaluated in a new light. As aforementioned, PIC technologies and designs vary widely. Each option's value added must be carefully weighed against the value subtracted. Examples of value-added features include but are not limited to: No laser alignment, isolator, or Thermoelectric cooler (TEC) needed. Also, fewer voltages and control loops might be needed. Examples of value-subtracting features of a PIC might include too many AC coupling capacitors, special drivers, special voltages, or bias-T's needed. An ideal PIC would be able to use the built-in drivers inside the latest DSPs, include integrated

The 4xFR4 example illustrates the potential of PICs in optical transceivers. Making something smaller does not necessarily make it lower power, and often has the opposite effect. However, the greater level of integration of PICs allows for common resource sharing, improving power per bit. Also, making something smaller does not necessarily make it cheaper either, and it often has the opposite effect. Again, the greater level of integration of PICs allows for fewer manufacturing steps in what is a much more complicated optical assembly. All the benefits of optical integration parallels those offered by electronic integration, which is why the optical communication industry is pursuing PICs with such fervour.

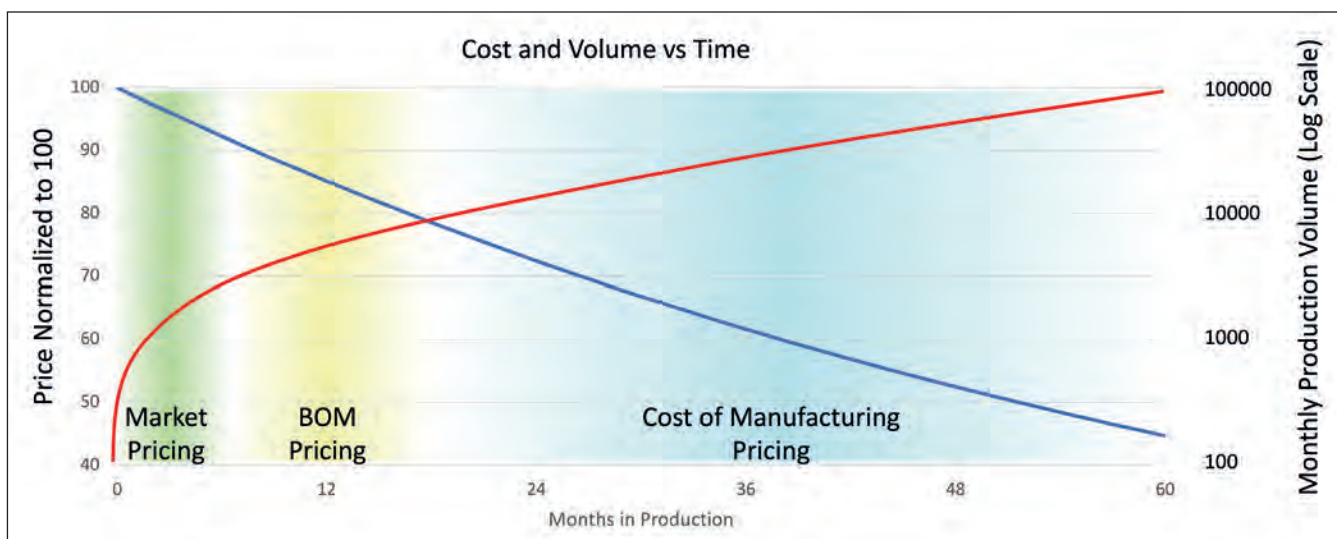

► The economic lifecycle of an optical transceiver is complex. Here production volume is plotted against cost of manufacturing. Note there are several distinct phases where pricing is determined by differing factors.

NEW



Automated Mixed-signal Electro-optical On-wafer Test

- Wafer-level handling & test
- Test-&-qualify of on-wafer devices
- Combined, configurable electro-optical probing
- Waveguides, PICs & hybrid integrated devices

Hybrid Photonic Integration:

Transferring concepts from the communications bands into short wavelengths

Photonic integration at wavelengths outside the classical communications bands in the infrared has the potential to enable new applications in sensing, analytics and quantum technologies. Hybrid integration approaches, such as Fraunhofer HHI's PolyBoard, allow for the transfer of device concepts towards shorter wavelengths while at the same time leveraging the technology of mature PIC platforms.

BY MORITZ KLEINERT, [FRAUNHOFER HHI](#)

OPTICAL COMMUNICATIONS as a large market relying on mature fiber-optic infrastructure has been the main driver of the push towards photonic integration over the last decade. This resulted in the development of various photonic integration platforms that cater for classical fiber-optics communications bands in the infrared around 1300 nm and 1550 nm. These include monolithic

semiconductor-based platforms such as InP and SOI as well as hybrid insulator-based ones such as Si_3N_4 and polymers. These technologies, developed for optical communications, have enabled the fabrication of PICs for applications with lower maturity in sensing, analytics, optical computing, and other areas. This approach has proven successful for applications that can operate in the infrared

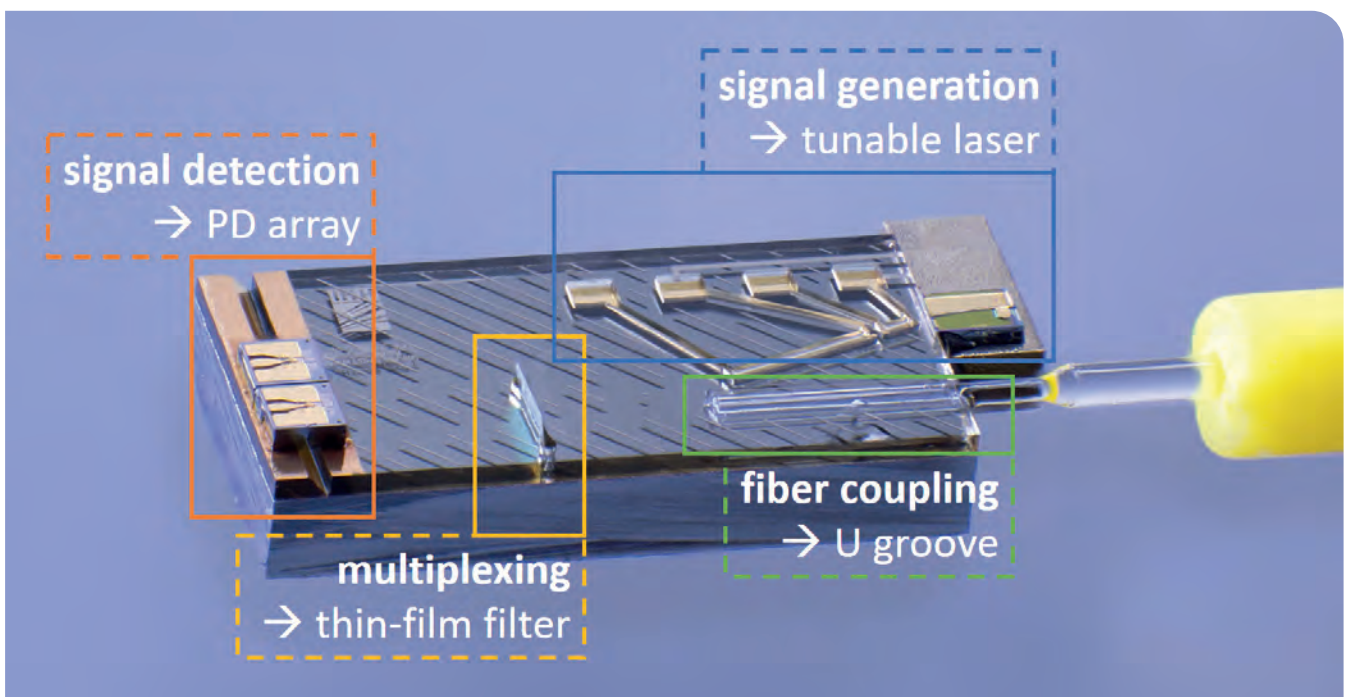

► Figure 1. Optical network unit fabricated in the PolyBoard platform for the C and L band. The functional building blocks of the PIC are highlighted. (Fraunhofer HHI / EOS Edition)

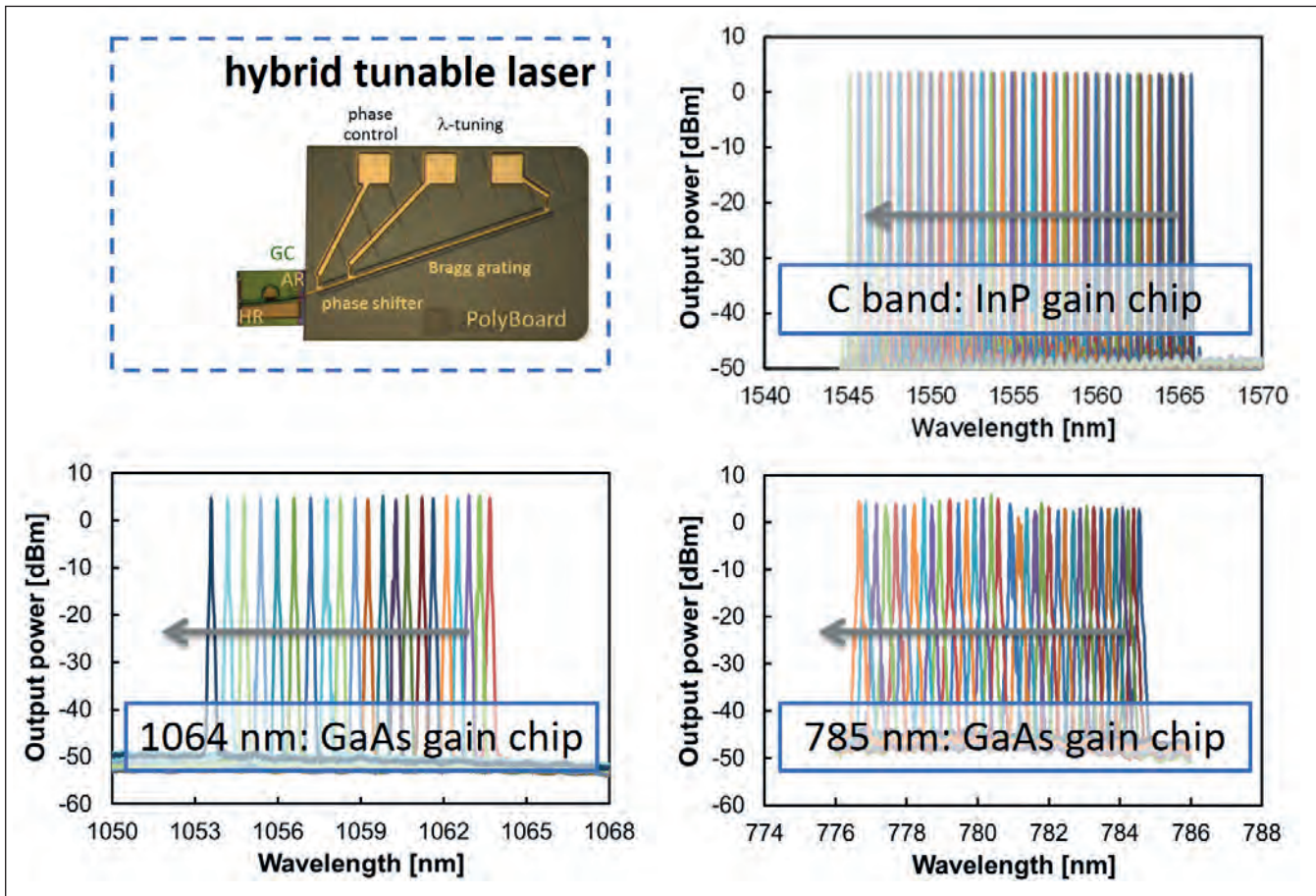

wavelength ranges covered by the established platforms. However, it excludes a broad range of photonic systems that must operate at other, especially shorter, wavelengths due to constraints imposed by physics, but would nevertheless greatly benefit from photonic integration.

InP- and SOI-based platforms cannot address this issue, because they become absorbing at shorter wavelengths. Monolithic photonic integration in other material platforms suitable for these spectral regions, such as GaAs, would be possible but would require the development of new technologies, thus forfeiting the economies of scale associated with the use of mature platforms designed for communication.

In this context, hybrid photonic integration is preferable to the two aforementioned options, as it allows for the combination of individual active photonic components (laser diodes, photodetectors, and modulators) from various material systems with integrated passive waveguides with broad spectral transparency to form complex chips.

In this way, the development of PICs for short wavelengths only requires the availability of suitable active components and the adaptation of the PIC building block designs to the operating wavelength of the respective application, but not the development

of a new technology line. The PolyBoard platform developed by Fraunhofer HHI uses such a hybrid integration approach. It relies on polymer channel waveguides fabricated with standard wafer-scale clean room processes and comprises various functional building blocks developed for the infrared fiber-optical communications bands. Figure 1 shows an optical network unit (ONU) for passive optical networks in FTTx applications [1]. This ONU is a bidirectional device, receiving downstream data in the L band and transmitting upstream data in a selectable DWDM channel in the C band. The single optical fiber carrying the up- and downstream data is passively coupled to the PolyBoard PIC via an etched U groove structure [2]. The upstream in the C band is generated by a hybrid tunable DBR laser [2]. Bottom-illuminated InP photodiodes detect the downstream signal in the L band. They are placed on top of micro-machined, gold-coated 45° mirrors that deflect light from the waveguide plane into the detectors. Upstream and downstream are separated from the same integrated waveguide by a dichroic mirror, realized as a thin-film filter (TFF).

While the above-mentioned functional building blocks were developed for the C band around 1550 nm, the hybrid integration approach allows for the transfer of these functionalities to other wavelengths. This is facilitated by the broad spectral transparency of the passive PolyBoard waveguides from the infrared to the visible. Hence, it is possible

► Figure 2. Schematic of hybrid tunable laser and optical spectra obtained from lasers around 1565 nm, 1064 nm and 785 nm.

► Figure 3. Thin-film filters in the PolyBoard platform and optical spectra of a C/L band splitter and a 785 nm pump light filter.

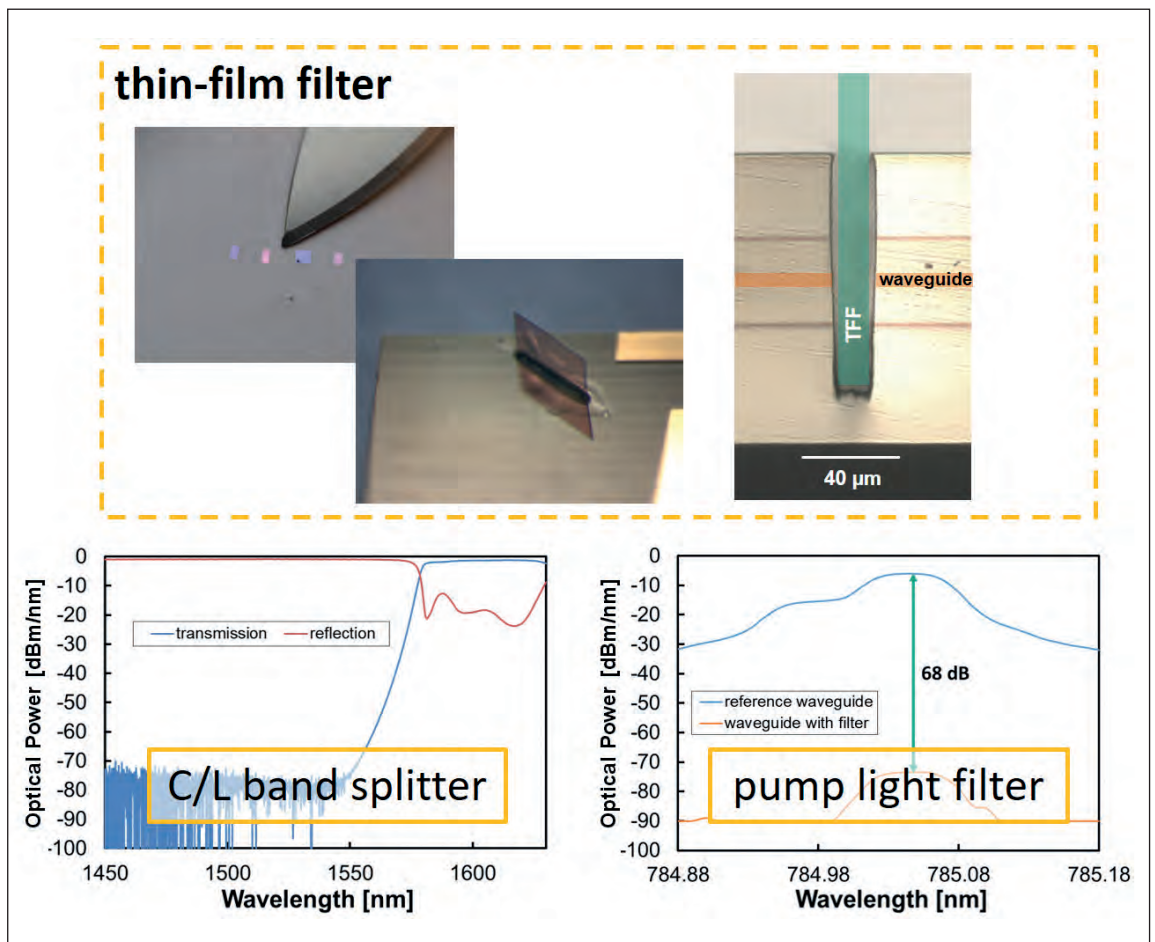

to design transparent single-mode waveguides for the entire spectral band. Transferring signal detection to smaller wavelengths is straightforward because PD integration via mirrors allows for the use of planar PDs manufactured in material systems such as GaAs and Si. The approach to adapt the other functional building blocks is described in the following sections.

Tunable lasers as light sources

The hybrid integration concept of the tunable laser in the PolyBoard platform is presented in the top left of Figure 2. Photons are generated in a III/V semiconductor gain chip (GC) that has a highly reflective (HR) coating against air on one facet and an anti-reflective (AR) coating against the polymer waveguide on the other facet. The waveguide at the facet of the gain chip is angled to further reduce unwanted reflections and butt-joined coupled to the PolyBoard chip. The second facet of the laser cavity is formed by a Bragg grating in the integrated waveguide. Localized heating of the Bragg waveguide with the heating electrode allows for the tuning of the wavelength reflected by the grating and thus the wavelength of the laser emission. An additional thermo-optic phase shifter enables fine-tuning of the phase of the longitudinal laser mode. The standard implementation of the hybrid tunable laser structure uses an InP gain chip, which provides

optical gain in the C band, and a Bragg grating designed to reflect a wavelength in this range. The tuning of the emission spectrum of such a laser is shown in the top left of Figure 2. Various variants of this building block, e.g. for direct modulation and for a narrow optical linewidth, are available. The ONU of Figure 1 uses a tunable laser that allows direct modulation of the upstream signal at 10 Gbit/s. The transfer of this building block to shorter wavelengths involves two aspects. Firstly, the gain chip has to be fabricated in a material system that provides gain in the desired spectral bands. Secondly, the parameters of the Bragg grating must be re-designed to match the output wavelength. However, the basic layout, fabrication techniques, assembly processes, and control electronics do not need to be changed. The measurement results obtained from hybrid tunable lasers at 1064 nm and 785 nm with GaAs GCs shown in the lower row of Figure 2 prove the feasibility of this approach [4].

Thin-film filters for wavelength and polarization handling

In addition to the usual waveguide-integrated filters such as Bragg gratings or arrayed waveguide gratings, the PolyBoard platform offers thin-film filters as a means of spectral filtering and polarization handling. These TFFs consist of a μm -thin polymer carrier film and a dielectric layer

U groove and micro-optical bench

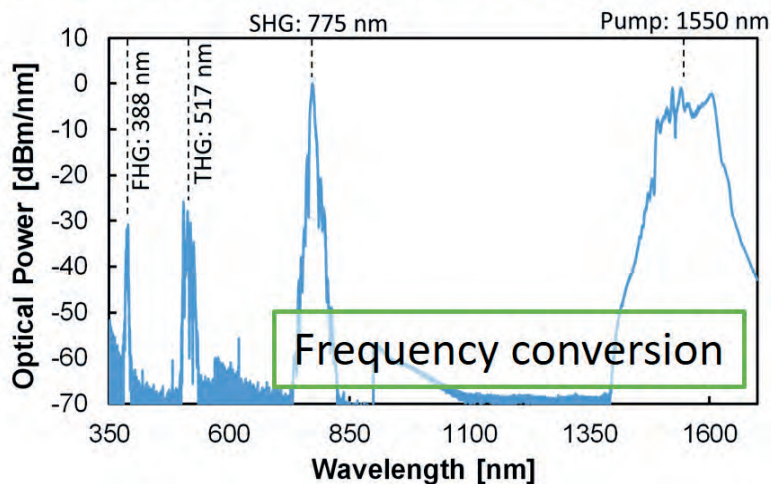
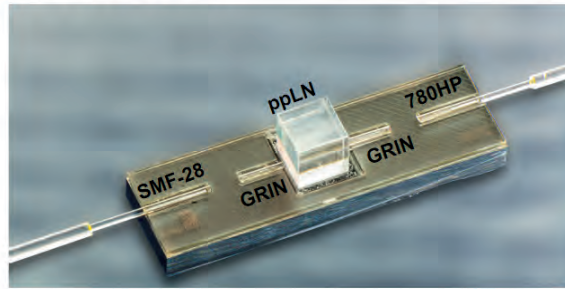
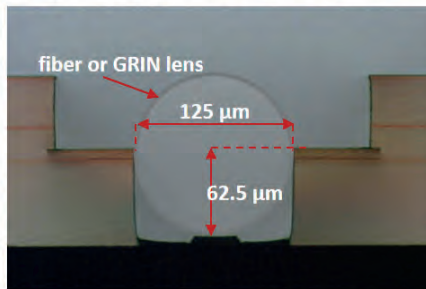

► Figure 4. Cross section of a U groove and PolyBoard chip for non-linear frequency conversion with corresponding spectrum.

stack that realizes the intended filter functionality. Hence, filtering properties of coated free-space optics can be transferred directly to integrated optics for all relevant optical wavelengths. The TFFs are fabricated on wafer-scale and are therefore compatible with the scaling of PIC fabrication. The top row of Figure 3 shows TFFs after removal from the wafer and after insertion into the slots etched perpendicularly into the waveguide layer of the PolyBoard chip.

The measured spectral characteristics of the TFF used in the ONU are shown in the lower left of Figure 3. Here, the dielectric layer stack is designed to reflect the C band emission from the tunable laser and transmit the L band downstream from the

network. Since the etched slots on the PolyBoard chip are the same for all spectral bands, transferring this functionality to shorter wavelengths requires only the design of an appropriate dielectric filter stack. An example is shown in the lower right of Figure 3. This filter was designed specifically for quantum technology applications that use non-linear crystals pumped at 785 nm to create a photon pair in the C band. After the non-linear process, the pump light must be filtered out of the integrated waveguide to avoid contaminating the generated stream of photon pairs. Using the TFF approach, the high pump suppression achieved with dielectric coatings in free-space optics can be applied to integrated optics. In this case, a pump suppression of 68 dB inside the PIC waveguide was confirmed,

Filtering properties of coated free-space optics can be transferred directly to integrated optics for all relevant optical wavelengths. The TFFs are fabricated on wafer-scale and are therefore compatible with the scaling of wafer-scale PIC fabrication

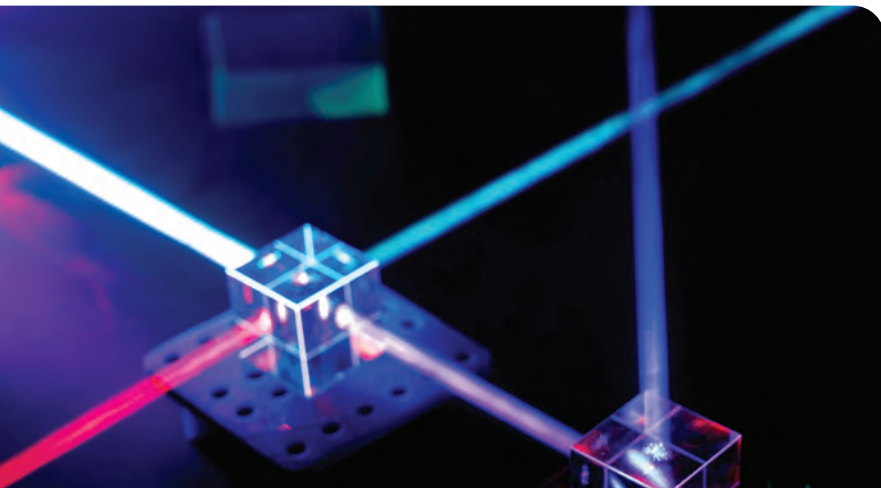

meaning that only one in 6.3 million pump photons unintentionally passes through the filter [4]. In addition to the two examples shown here, there are many other TFFs for spectral and polarization filtering from the visible to the infrared available.

U Grooves for fiber coupling and micro-optical benches

Reliable optical coupling between single-mode fibers and integrated chips is one of the greatest challenges in manufacturing PIC-based optical assemblies and modules. In contrast to the usually required active alignment, in the PolyBoard platform U grooves allow for a passive single-mode coupling with sub- μm precision. A cross section of a U groove is presented in the top left of Figure 4. The fiber is held in place by a U-shaped trench etched into the polymer layer of the PIC. The width of the trench corresponds to the 125- μm diameter of standard optical fibers. As the PolyBoard waveguides and the U groove are defined in the same lithographic step,

the horizontal alignment between the fiber core and the PIC waveguide is nearly perfect. Vertical alignment is controlled by a precise wafer-scale dry etching process so that the depth of the etched trench is half the fiber diameter. This approach is suitable for all wavelengths at which single-mode optical fibers with a standard diameter of 125 μm are available.

A chip using U grooves for coupling a SMF-28 fiber for the C band and a 780HP for 780 nm is presented in the top right of Figure 4. Despite the two U grooves for fiber coupling, this chip features two additional U grooves for the insertion 125- μm diameter graded-index (GRIN) lenses. These lenses are designed to create a collimated or focused beam within the etched free-space section on the chip. This approach allows for the combination of bulk crystals, e.g. for non-linear or non-reciprocal optical crystals, with PICs. Here, a periodically poled lithium niobate (ppLN) crystal is inserted into the PIC. When pumped with light around 1550 nm, the non-linear optical properties of the crystal enables the generation of second harmonic (SHG) light around 775 nm. Despite the second harmonic with an optical power of up to 8.2 dBm, higher harmonics at 517 nm and 388 nm are also coupled into the fiber [5]. The broad transparency of the passive polymer waveguides in this hybrid integration approach combined with the on-chip micro-optical bench therefore enables PICs for efficient on-chip optical frequency conversion with applications in sensing and quantum technologies.

Conclusion and outlook

The flexibility of hybrid photonic integration in selecting optimal active components and independently optimizing on-chip functional building blocks shows great potential to meet the market needs for PICs at wavelengths shorter than standard communications bands. Although essential PIC building blocks have already been transferred and successfully demonstrated, challenges remain on the path towards complete PIC platforms for short wavelengths. One of these is the still limited availability of active components, especially lasers, for some spectral regions in the visible range.

To some degree, this can be circumvented by using on-chip non-linear processes for frequency doubling of infrared light, as shown in Figure 4. Another challenge is long-term stable optical coupling at short wavelengths, such as green or blue. Due to the high optical power densities at the facets of the single-mode waveguides and the high photon energies, the design of these interfaces is significantly more demanding than for infrared wavelengths. By further addressing these challenges and building upon the extensive experience gained in the design, fabrication, assembly, and control of PICs for communications bands, hybrid integration is one of most promising photonic technologies for short wavelengths.

REFERENCES

- [1] Zhang, Ziyang, et al. "C/L-band colorless ONU based on polymer bidirectional optical subassembly." *Journal of Lightwave Technology* 33.6 (2015): 1230-1234.
- [2] Kleinert, Moritz, et al. "Recent progress in InP/polymer-based devices for telecom and data center applications." *Integrated Optics: Devices, Materials, and Technologies XIX* 9365 (2015): 92-105.
- [3] de Felipe, David, et al. "Polymer-based external cavity lasers: Tuning efficiency, reliability, and polarization diversity." *IEEE Photonics Technology Letters* 26.14 (2014): 1391-1394.
- [4] Kleinert, Moritz, et al. "Hybrid Polymer Integration for Communications, Sensing and Quantum Technologies from the Visible to the Infrared." 2021 European Conference on Optical Communication (ECOC). IEEE, 2021.
- [5] Conradi, Hauke, et al. "Second Harmonic Generation in Polymer Photonic Integrated Circuits." *Journal of Lightwave Technology* 39.7 (2020): 2123-2129.

PROFESSIONAL SIMULATION TOOLS & EXPERT DESIGN SERVICES



Transmission Systems & Optical Components
VPIphotonics Design Suite™



Lab-proven DSP Algorithms
VPItoolkit™ DSP Library

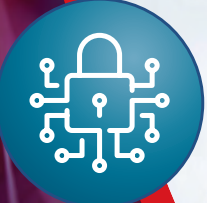

Quantum Key Distribution
VPItoolkit™ QKD



Integrated Devices, Waveguides & Fibers
VPIdeviceDesigner™



Cost-optimized Network Planning
VPIlinkConfigurator™



**Evaluate
now!**



Co-packaged optics for hyperscale data centres

The continuing push for greater efficiency, smaller form factors and faster throughput is leading to the development of next-generation co-packaged optics for datacentres and related applications. EPIC explores continuing research from major manufacturers working to keep the data moving while the world's appetite from broadband grows with each passing day.

BY IVAN NIKITSKIY, PROGRAM MANAGER,
PHOTONICS TECHNOLOGIES, EUROPEAN
PHOTONICS INDUSTRY CONSORTIUM (EPIC)

WITH DATA CENTRE TRAFFIC growing at an unprecedented pace, fuelled by advances in AI and Machine Learning, networking infrastructure must scale in capacity while maintaining or even reducing its total power consumption and footprint. How is the industry going to move forward to hyperscale data center operations with the introduction of next-generation / second-generation Co-Packaged Optics (CPO)? Here we overview how the large industry players, members of EPIC – the European Photonics Industry Consortium – address user requirements for CPO from different perspectives.

HiSilicon (a Huawei company), China

Huawei is a major player in co-package optics, and their Advanced Photonic section develops the photonic optical components that go into Huawei's larger systems. They are currently addressing the challenges of developing 100 Tbit/s co-packaged optics. Eric Bernier, Leader of Advanced Photonics at HiSilicon Technologies in Canada, the former

ASIC Design Center of Huawei explains: the general consensus within the industry is that at the bandwidth required by a 100 Tbit/s switch, it becomes impossible to move the data electronically without consuming the entire power budget for the switch chip. As a consequence, at 100 Tbit/s, co-packaged optics are essential. But from a module perspective, it's not possible to double the number of modules because of reliability issues and also because it becomes harder to package. As a result, the solution for achieving the required higher density will be to increase the capacity of the co-packaged optics to around 200 Gbit/s per fiber coming out of each module with multiple wavelengths per fiber. This will require inputting more optical power into the system, and although a lot of progress has been made, Bernier believes that ultimately, they will need new technology.

For this reason, they are presently engaged on two research projects initiated by The International Photonics Advocacy Coalition (IPAC). One aims to develop a standard form factor for the external laser source, and the other is looking at the issues, the system architectures and the evolution of the electronics that are limiting 100 Tbit/s co-packaged optics. Currently, it is generally assumed that any future device will incorporate a connector because it will be easier for the supply and assembly chains. However, if the aim is to increase density while simultaneously reducing the power requirement on the staircase, the connector may have to be eliminated.

Senko Advanced Components Inc., Japan:

Tiger Ninomiya, Senior Technologist at Senko Advanced Components in the US, identifies four main challenges for CPO connectors in a data centre switch applications: 1) an increase in fiber count and how to arrange the fibers in and out; 2)

a use of external laser sources; 3) a change in face plate density that requires reserved spaces for laser sources and TRx channels, and 4) the challenge of internal fiber routing as fibers are now inside the system.

As regards to fibre count increase, the 12.8 terabit switch typically has 32 ports with eight fibers per transfer module that adds up to a total of 256 fibers in the case of using parallel optics. Similarly, the 51.2 terabits switch with CPO has 16 modules embedded on the switch ASIC substrate. And with parallel optics, each one of CPO optical engines can have up to 64 fibers, which adds up to a total of 1,024 fibres just for TRx – 4 times what they are dealing with now.

The issue with faceplate density derives from the need to have more fibers and to find space for external laser sources. The MPO connector has better density over duplex types of connectors. However, there is a correlation between fiber count per connector and optical performance. With a larger fiber count, it becomes challenging to maintain the lower loss, especially having multiple rows of multi fibers such as MPO-24 and MPO-32.

Senko is addressing this issue with their SN-MT connector carrying 16 fibers per connector, which improves fiber density at the panel while maintaining lower loss. Compared with MPO connectors, the SN-MT is roughly half the size and has a 2.7x density increase compared with MPO-16F. SN-MT even provides a better density than MPO-24 and MPO-32, while using a 1-row type ferrule, the optical performance is comparable to 1-row MPO. Senko also uses other technologies to overcome face plate density issues. These include fiber routing options for mid-board connectors; a fibre routing shuffle box, and backplane connectors.

► Figure 1. Evolution of fiber density, insertion losses, and fiber count per connector by Senko Advanced Components Inc.

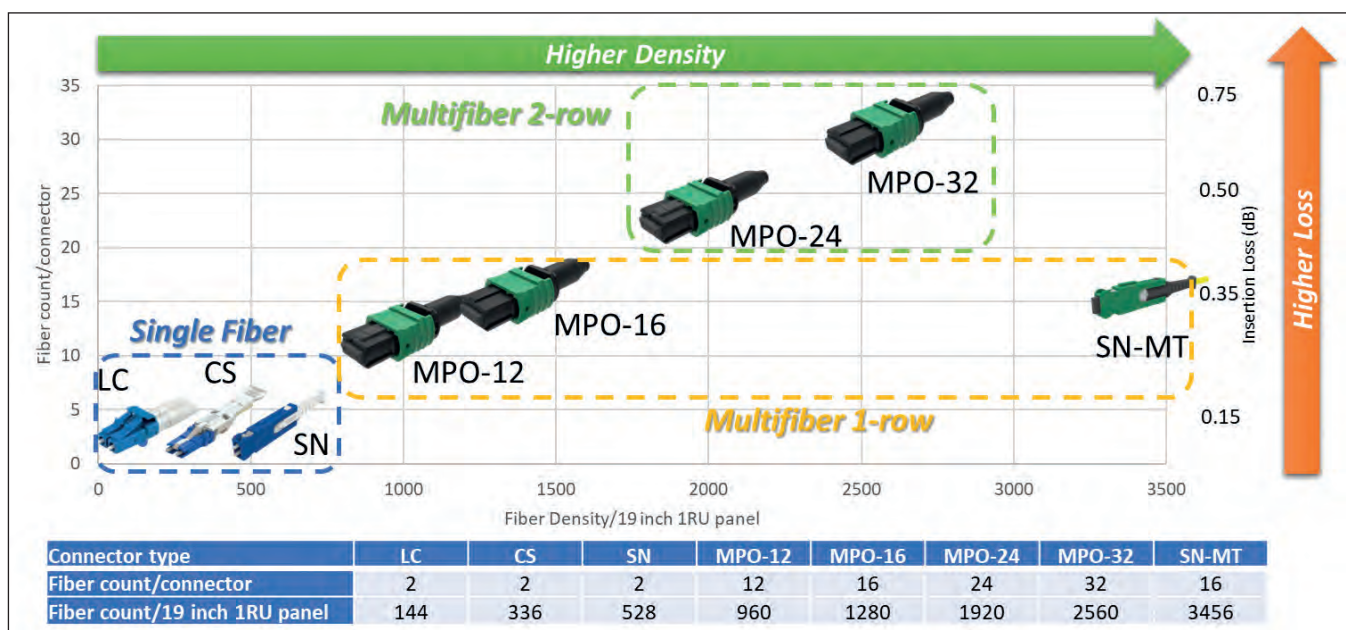

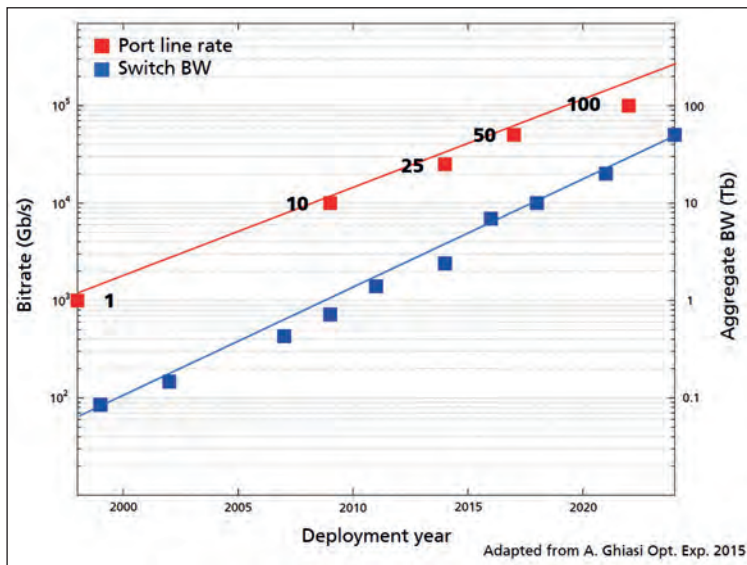

► Figure 2. Evolution of switch and transceiver bandwidths. Adapted from [2]

The Consortium of On-Board Optics (COBO) and Co-Packaged Optics Working Group, which Tiger is chairing, aims to provide technical guidance and standards for CPO implementations focusing on optical connectivity and remote laser sources. In July 2022 they released a white paper on optical connectivity that details how these technologies can be utilized. [1]

OFS Optics (a Furukawa company), USA:
 OFS Optics has been involved across many different specialty fibre applications and markets for the better part of 30 years. Specifically in the telecom and datacom space, they work mainly with OEMs supplying erbium doped fibres, polarization maintaining fibres, and low bend loss fibres. Recently, OFS has been developing new novel fibre types such as hollow core and multi-core fibres. They are also developing external laser source (ELS) modules for co-packaged optics.

For John Earnhardt, Director of Sales at OFS Speciality, the transition of going from copper dominant to fiber dominant has created a number of challenges. From a fiber optic perspective, with

OFS Optics, a Furukawa company, has been involved across many different specialty fibre applications and markets for the better part of 30 years. Specifically in the telecom and datacom space

both PM and single mode fibres, there's the issue of mode field diameter. In some cases, users want a conventional nine micron type mode field diameter and in other cases they want atypical mode field sizes that interface directly with the chip – options might be in a three micron mode field and a couple of options in between three and nine micron.

Low bend loss is becoming increasingly important as transceiver modules shrink in size and go to QSFPDD and OSFP and there will likely be pressure on low bend loss as well in the CPO area. With PM fibres, there are potential issues regarding traditional PM properties like beat length and PER and so on. Another area of concern is multi-path interference, particularly with the move to low bend loss fibres together with potential mis-match the mode field diameters when splicing together two fibres.

In addition to optical considerations, there are mechanical ones. In this regard, they are seeing increasing pressure to improve their tolerances, in relation, for example to core clad offset, core diameter and clad diameter. The mechanical properties directly impact the overall efficiency of laser delivery through fibres. As regards the question of clad diameter i.e., 80 micron or 125 micron, their initial ELS samples were based on a 125 cladding diameter, but they are seeing pressure for more 80 micron fibres, both PM and SMF for transceivers and other types of applications. OFS is also seeing two emerging trends in fiber coating. One is a smaller diameter, for example, moving from 165 to 135 micron for 80 micron cladding. The other is the increasing demand for alternative coatings that will survive at least for a short-term duration at higher temperatures with solder reflow, and possibly for a longer term duration in some photonic packages with local hot spots.

Fraunhofer IZM (Institute for Reliability and Microintegration), Germany:
 In the last decade, Fraunhofer IZM have been innovating in the area of computing and data center applications using photonic interconnects. They contribute in the areas of system concept and design, photonic- and RF- component design, signal integrity & board design, silicon photonics interposer, developed with through silicon wire technologies, 3D integration, flip chip assembly, co-packaging, system evaluation and benchmarking.

In the field of CPO they started with a flagship project for data centre interconnects with the goal to utilize optical interconnections and 3D integration technologies to make data centres and high-performance computers faster on all levels: rack-to-rack, board-to-board and chip-to-chip. More recently, they have been involved in the MASSTART project, which was set up to facilitate the high volume manufacturing of Tb/s inter and intra data center transceivers.

For Tolga Tekin, Group Manager at Fraunhofer IZM, a major challenge for data center network topology is that more than 70% of the traffic stays inside the data center. This means that the interfaces need to have enough capability and symmetry to connect all of the nodes. The transceiver data rate follows the Ethernet switch port speed. The serializer/deserializer (SerDes) speed is defining the port speed of the transceiver. The packaging constraints limit chip radix to 256 (512) ports/ASIC. Even though the SerDes arrays are constantly evolving to support higher bitrate, the power consumption of SerDes increases with bitrate.

The acceptance of the solutions depends on their costs. For the typical single mode data center transceiver, the target is \$1 per Gbps, so the cost of the optics for a transceiver with 32 ports on the switch front panel is \$10-13k, making the transceiver cost for the entire data center around \$50 million. Accordingly, Fraunhofer is developing a cost cutting strategy based on decoupling the I/O from the logic system. The effect is to reduce the power consumption of chip I/O from 180 watts for their 25 terabit switch ASIC to 40 watts. At the same time, they have been able to increase the link reach thereby reducing loss from 12 dB to 1 dB. Recently completed EU-project L3MATRIX has been devoted to large-scale silicon photonics matrix for low power and low cost data centres.

This project aimed to improve the underlying network technology with photonic switching to enable scale performance whilst keeping power consumption under control. In the co-packaged optics, a fiber array is coupled directly using micro lens arrays combined with integrated III-V and silicon photonics and directly attached to the switch ASIC. They have focused on 25 terabit switches with co-packaged optics using a 2D transceiver array based on silicon photonics with integrated III-V materials. These devices address up to 256 lanes

The transceiver data rate follows the Ethernet switch port speed. The serializer/deserializer (SerDes) speed is defining the port speed of the transceiver. The packaging constraints limit chip radix to 256 (512) ports/ASIC. Even though the SerDes arrays are constantly evolving to support higher bitrate, the power consumption of SerDes increases with bitrate

and use integrated lasers by bonding III-V layers on silicon photonics in Mach-Zehnder configuration. Altogether, the future of Co-Packaged Optics is about creating a new ecosystem, which is going to involve efforts from component manufactures and higher level system integrators to create a network, involving everyone in the industry, to develop the right standards and to design and integrate these new components and to scale production.

REFERENCE

- [1] https://www.onboardoptics.org/_files/ugd/8abe6c_708f0fd7e75c4415b5eca3e35f7d1116.pdf
- [2] A. Ghiasi, "Large data centers interconnect bottlenecks," Opt. Express, no. 23, pp. 2085-2090, 2015.

 **ANGELTECH**

 **CS INTERNATIONAL CONFERENCE**

 **PIC INTERNATIONAL CONFERENCE**

 **PE INTERNATIONAL CONFERENCE**

Talk to us about sponsorship **NOW**
as it will be another full house

Contact us at: info@angel-tech.net

Or call us on +44 (0)2476 718970 and speak to
Sukhi Bhadal or **Stephen Whitehurst**

SAVE THE DATE

18-19

APRIL 2023

**SHERATON BRUSSELS
AIRPORT HOTEL BELGIUM**

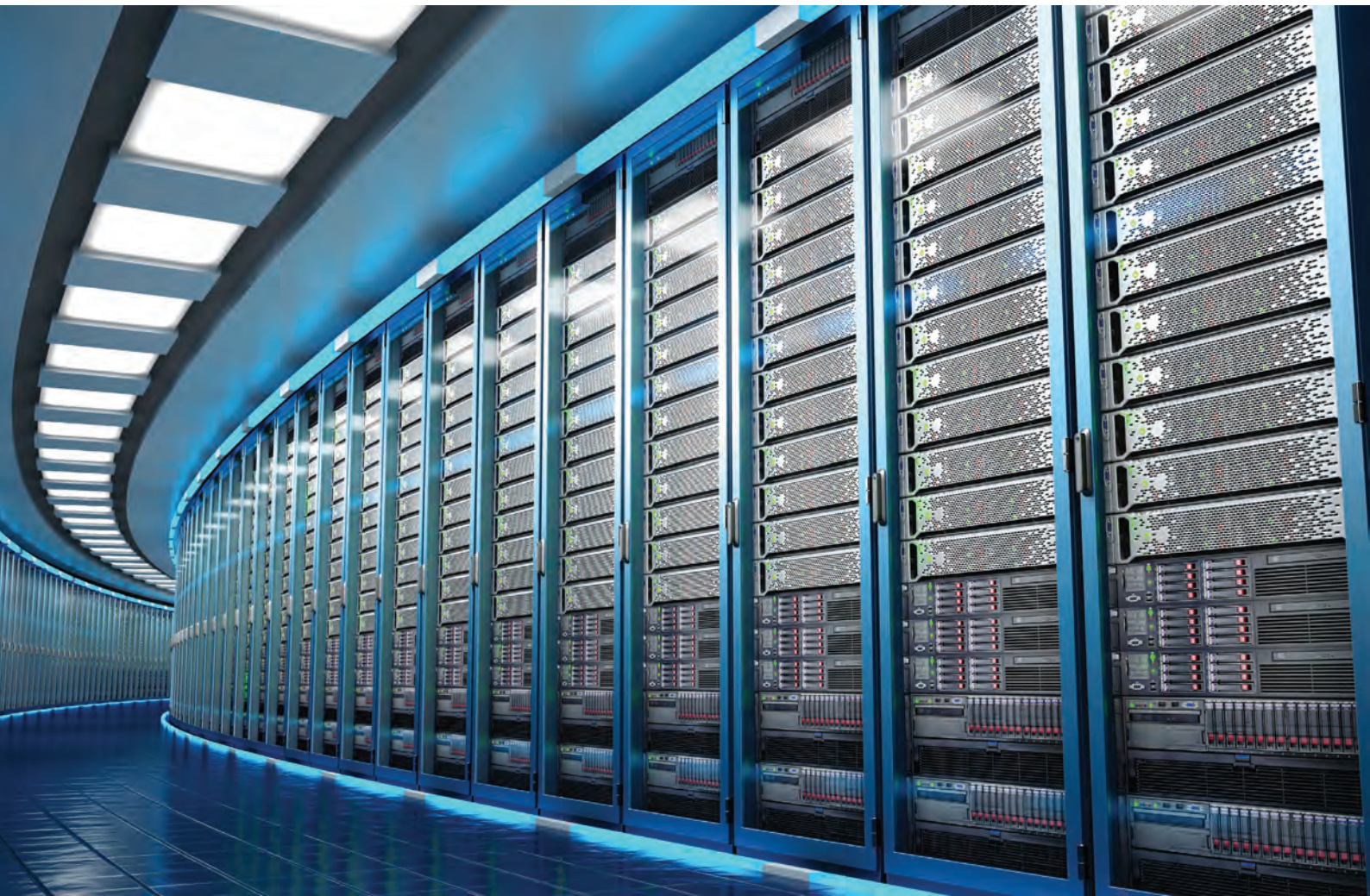

PIC T&M must evolve to meet passive and active component needs

Datacentre developers look to PIC-based transceivers as a means to handle increasingly large volumes through greater efficiency, smaller size and cooler operating temperatures. But datacentres typically utilize 50,000 or more transceivers, which creates a testing conundrum and bottlenecks for manufacturers. The experts at EXFO describe how T&M is evolving to meet these demands.

BY ALDO GUTIERREZ, PH.D., EXFO PRODUCT LINE MANAGER, [EXFO](#)

NETWORK TRANSFORMATIONS are underway around the world at a breakneck rate, as operators strive to extend the benefits of high-speed optical networking and 5G mobility to their customers. Enabling those transformations are the research, design, and manufacturing innovations being implemented by component manufacturers working to keep pace with the evolution of speeds and feeds at the network and data center level.

Each data center can have as many as 50,000 transceivers deployed, and transceiver manufacturers are challenged to produce thousands of devices daily. There is growing demand for connected devices and integrated optics at the component level that are faster, highly reliable, and more compact than ever before.

One of the biggest challenges is to produce high-quality, advanced transceivers in volume while

► Testing active components with OSA and optical oscilloscope

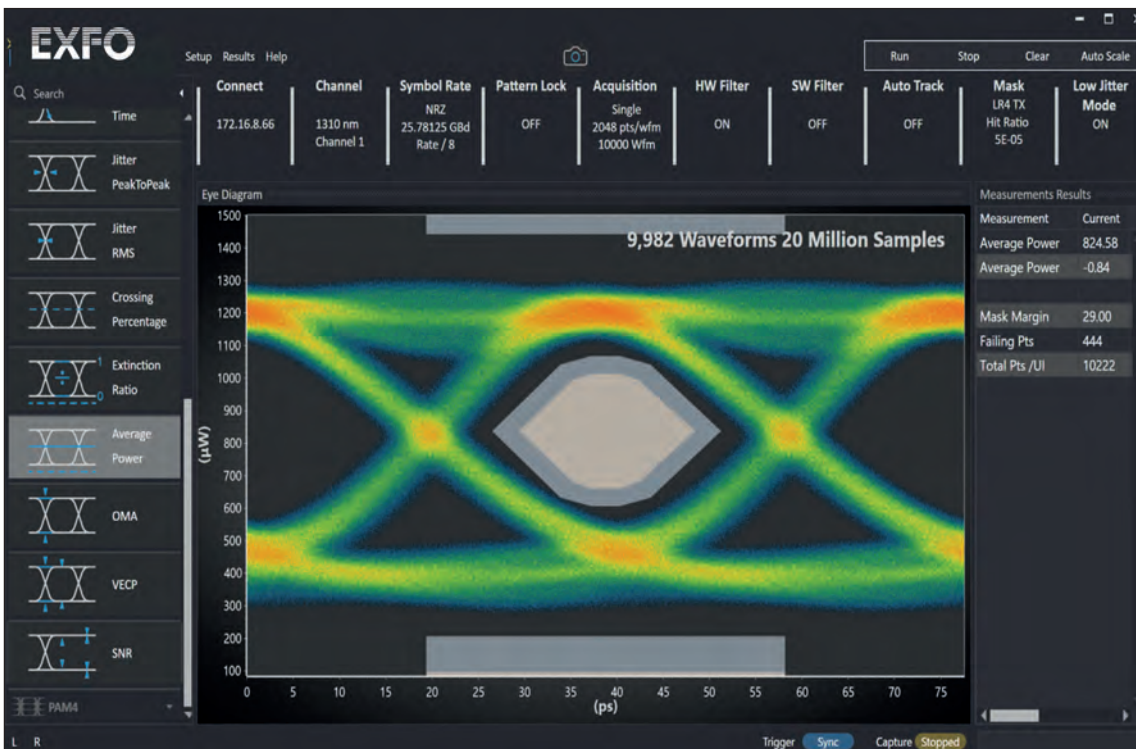
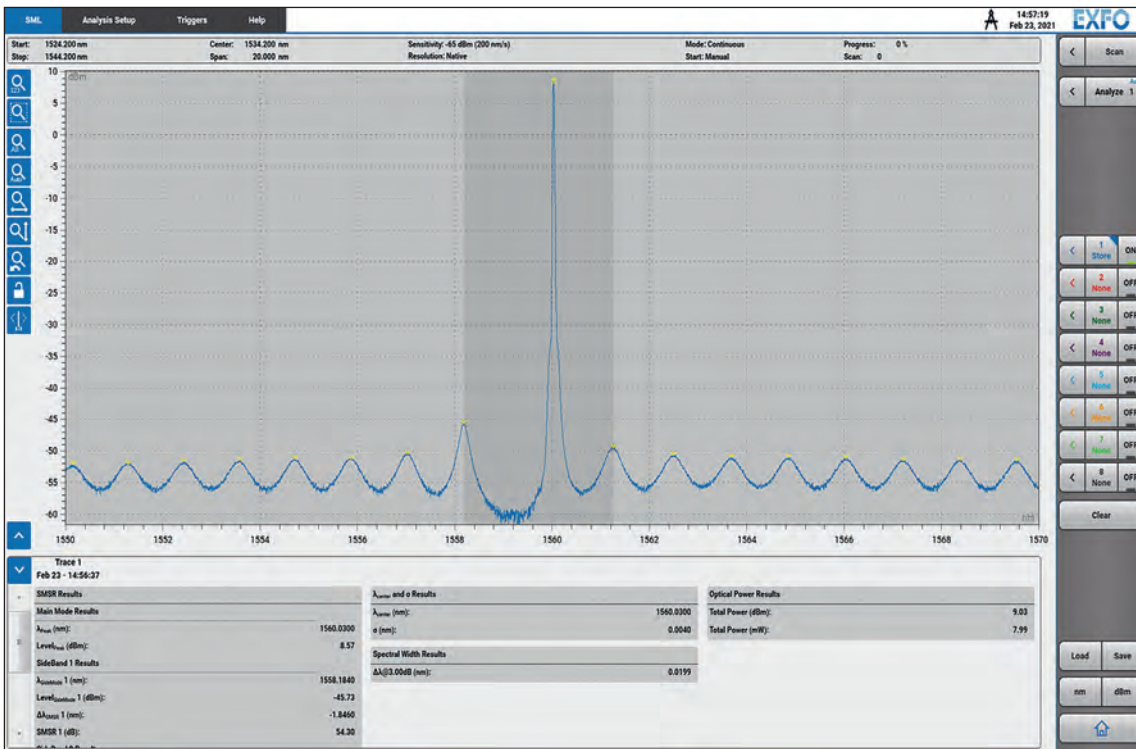

ensuring that heat production can be managed for these devices. Photonic Integrated Circuit (PIC) solutions are being adopted by transceiver manufacturers to address the reduced size and complexity challenges while also addressing heat management issues experienced in today's data centers.

This article will examine the trend to adopt PIC-based transceivers, and how testing both

passive and active components is key to enabling production of next-generation, PIC-based transceivers.

Today's reality

By using PIC technology to consolidate and integrate various components on a single chip, functionality can be increased while increasing density, lowering the cost of production, and reducing energy requirements.

➤ Swept IL measurement of ring resonator performed using the CTP10 test platform

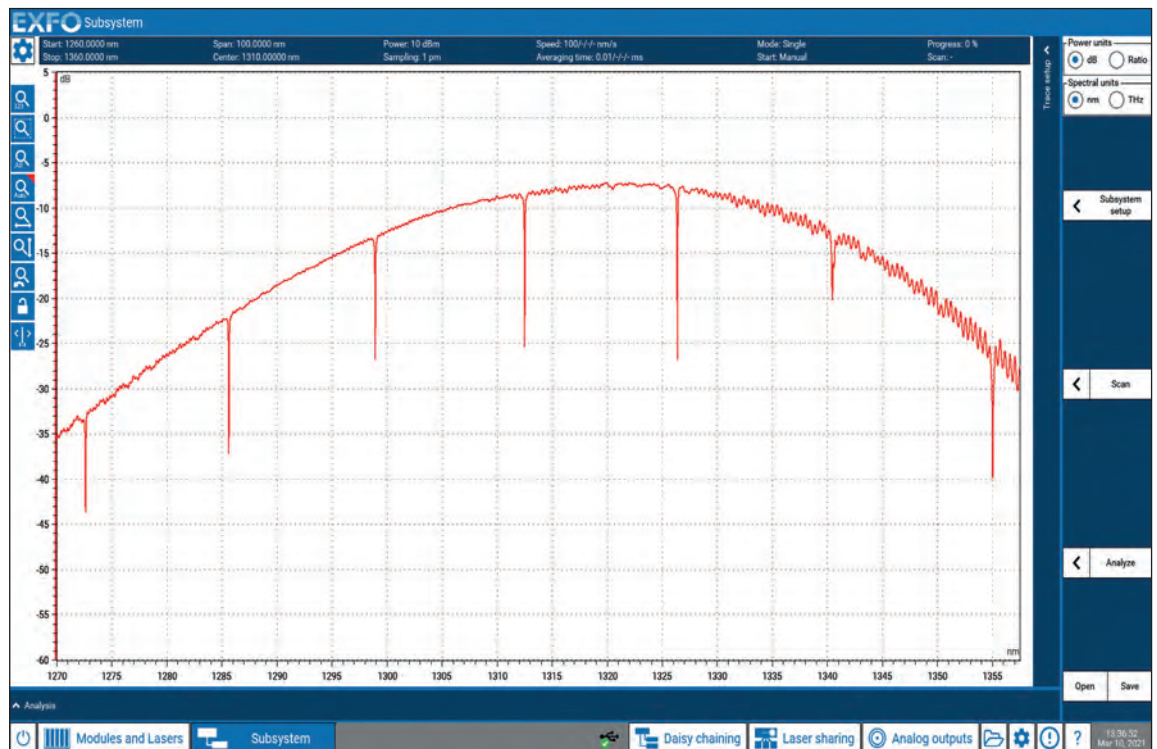

PIC testing can support the new generation of transceivers including 5G wireless transceivers, 800G transceivers, and coherent modules for high-speed networking. While in the past transceivers were only electronics-based, the new wave of transceivers incorporates both optical and electrical elements, increasing the complexity of design and production.

Testing – the critical element

Even with design improvements enabled by PIC solutions, there are still challenges inherent in delivering thousands of components each day. There are often bottlenecks on foundry lines due to the sheer volume of units and even the multiple ports-per-unit needing testing. Component testing throughout the design, foundry, and packaging stage is critical.

That means testing must be a consideration from the design stage through ports-per-unit to ensure that the test process is simplified, test time per unit is reduced, and bottlenecks are avoided. And fortunately, innovation in light coupling methods has made wafer-level testing possible for mass production. EXFO is uniquely positioned as the only test & measurement (T&M) solutions provider that can offer both passive and active component testing.

Testing active optical components

Testing active components such as modulators, lasers, and amplifiers found on PICs is usually done using general test instruments. An optical spectrum analyzer (OSA) can be used to measure the spectral signal, and an optical oscilloscope

is used to measure the eye diagram of light sources.

The latest OSAs are extremely fast and can perform up to five scans per second at speeds of 2000 nm/s, enabling real-time component alignment with sufficiently high resolution to allow measurement of key parameters such as optical signal-to-noise ratio (OSNR) and side mode suppression ratio (SMSR).

Testing passive components

Testing PIC-based passive components is often challenging due to the high port count of some components like arrayed waveguide grating (AWG) or the sheer number of components to test on a single die. A component test platform is a multiport detection system that operates in conjunction with a continuously tunable laser to measure optical insertion loss, return loss and polarization-dependent loss across the laser's spectral range. The method yields optical spectrum quickly and with a high wavelength resolution, typically on the order of a picometer.

EXFO's CTP10 passive optical component tester with T100S-HP high-dynamic range tunable laser enables swept laser testing of passive optical components at a picometer resolution and at high speeds, even under the most stringent conditions. The auto-alignment capability of the CTP10 allows for finding the optimum optical in- and output connections of the PIC on wafer in the fastest time possible.

The CTP10 operates from 1240 to 1680 nm and covers a wide range of applications, including

telecom, sensing, and LiDAR. Its electronics and internal processor simplify data transfer. It can be remotely controlled using SCPI commands, facilitating integration as part of a larger-scale automated PIC test setup, which helps keep testing time to a bare minimum.

Automated component testing

With more functionalities being integrated onto a single PIC, new functional tests like bit-error-rate (BER) or eye diagram are needed in addition to the conventional parametric tests. This is true even at the wafer and die levels in order to fully characterize these increasingly more complex PIC devices.

Test & measurement companies, including EXFO, are leveraging automation to enable full control of end-to-end testing from wafer and die to packaging, as well as to simplify configuration and test processes – and to reduce time required between various test stages. That’s a challenge because each application demands a unique PIC solution that’s readily customized and quickly reconfigurable to optimize testing. Manufacturers need a turn-key solution that enables end-to-end testing in volume production settings.

EXFO continues to invest in automation and has made advances with flexible PIC test solutions that can scale to meet future requirements. EXFO has collaborated with other industry innovators

to deliver customized solutions. To best respond to varied customers with diverse product lineups, latest technology in ultra-high precision alignment systems, collision avoidance sensors, temperature control, machine vision, and electronic testing and photonics often need to be combined to provide a simple-to-use interface.

The future for PIC solutions

PIC technology has also increased in importance for industry segments beyond optical communications including co-packaged optics for next-generation high-speed transmission, automotive LiDAR for autonomous vehicles, and quantum communications for AI or machine learning applications.

These new PIC applications use diversified technology platforms and PIC designs, and also bring new challenges to PIC fabrication and testing. More modular and scalable PIC production and testing solutions will be needed to support wide-ranging PIC designs and to create the economy of scale needed to ensure competitive cost structure and return on investment. And testing from design to packaging to deployment will be key to success in providing next-generation PIC-driven solutions.

For more information on PIC testing solutions from EXFO, download the company’s application note: <https://www.exfo.com/en/testing-next-gen-pic-based-transceivers>

Test&Measurement
YOKOGAWA 



AQ6380 Optical Spectrum Analyzer

**Next generation
optical performance**

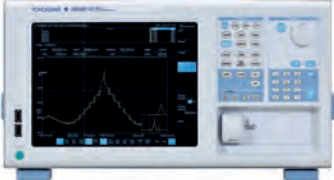

DISCOVER IT HERE:



Precision Making
www.tmi.yokogawa.com



Getting PICs off the ground

PICs based on InP and GaAs prepare to slash the size, weight and power of systems to be deployed in space and on-board aircraft for a variety of sensing applications

BY JONATHAN KLAMKIN, PAUL VERRINDER, VICTORIA ROSBOROUGH AND FENGQIAO SANG FROM THE [UNIVERSITY OF CALIFORNIA SANTA BARBARA](#)

ONE OF THE MOST powerful technologies of our time is the photonic integrated circuit (PIC). By integrating all the required functions on a single chip, the PIC significantly reduces the cost, size, and weight at the system level, while improving performance, stability, and reliability.

To produce this multi-faceted photonic device, wafers are processed in a manner that is similar to that employed for the electronic circuits that have revolutionised our society. However, the materials that are used can be somewhat different. While silicon is the semiconductor of choice for making electronic circuits, those employing photonics can also be formed from InP and GaAs. Both these III-Vs are attractive options, because they enable monolithic integration of gain material for light sources and their amplification.

Pioneers of the PIC developed this technology with telecommunications applications in mind. They focused on the centre-band, or C-band, which spans the spectral range from 1530 nm to 1565 nm, a domain associated with ultra-low-loss transmission of light through an optical fibre. Recently, though, PICs have gained traction in applications involving the O-band (1260 nm to 1360 nm), such as optical interconnects within and between data centres.

Note, though, that the potential for PICs is not limited to these wavelengths, nor to communications, or even to terrestrial applications. There are opportunities lying well beyond these boundaries, such as those we are exploring at the University of California, Santa Barbara (UCSB). We are targeting space and airborne applications of PICs, namely free-space communications, remote

lidar for gas sensing and topographical lidar. Our work on free-space communications has focused on extending the power-handling capabilities of InP PICs. Success on this front opens the door to higher data rates and/or longer link distances. Output powers with our InP PIC platform have exceeded 250 mW, a value far higher than any previous demonstration.

We have also broken new ground while participating in a NASA-funded project entitled IMPRESS Lidar – short for *Integrated Micro-Photonics for Remote Earth Science Sensing Lidar*. Through this project we have demonstrated the first ever fully functional PIC-based gas remote sensing lidar system that targets atmospheric CO₂. This system operates near a relatively weak absorption line that is centred at 1572.335 nm, a wavelength falling within the communications L-band (1565-1625 nm) that allows us to leverage mature InP PIC technology. Through this project we have been able to demonstrate a shrinking of the system volume by a factor of more than one hundred, compared with a system built with discrete components by collaborators at NASA.

Another avenue explored by our team has been the development of a GaAs-based PIC, which extends operation to other spectral domains. This tuneable laser PIC, developed for 10XX nm wavelengths, features beam-steering capability when it is used in conjunction with diffractive optical elements.

Sensing gases with InP PICs

Our InP PIC platform, equipped with high-efficiency lasers, provides broad wavelength coverage across the 1.2 μm to 1.6 μm range. This platform is ideal for active remote sensing of CO₂, which can be accomplished with a laser source at the sensing

wavelength of 1572.335 nm, using a sensing window of 30 GHz. A PIC-based approach for CO₂ sensing has many merits over the active remote sensing systems formed from commercial off-the-shelf optical components, which are compromised by their size, weight, and high power consumption. Usually, sensing experiments are performed from a near earth orbit, to minimise the high cost associated with launching large spacecraft into orbit. One of the strengths of our PIC technology, which has the potential to enable systems that are far more compact and power efficient, is that it could lead to increased deployment of this form of sensor on small spacecraft that launch more often.

The PICs we produce are designed and fabricated with what we refer to as an offset quantum-well platform. We deposit multi-quantum wells on top of a low-loss waveguide core in such a way that the wells are slightly offset from the centre of the vertical optical mode. Taking this approach enables us to selectively remove the wells to form separate active and passive regions. Coupling between those regions is high, typically between 90 and 95 percent, with reflections managed by angled interfaces. The active regions, where wells remain, provide gain in laser cavities and optical amplifiers. Meanwhile, the passive regions, where wells are absent, contain mirrors, filters, phase-tuning elements and optical modulators, as well as interconnects between sections and components (see Figure 2(a) for a sideview of the offset quantum well PIC platform used for InP CO₂ active sensor development).

To form our gratings, we etch into the waveguide core layer after defining active and passive regions. Adopting this approach enables us to form sampled

► Figure 1. Overview of III-V PIC fabrication process.

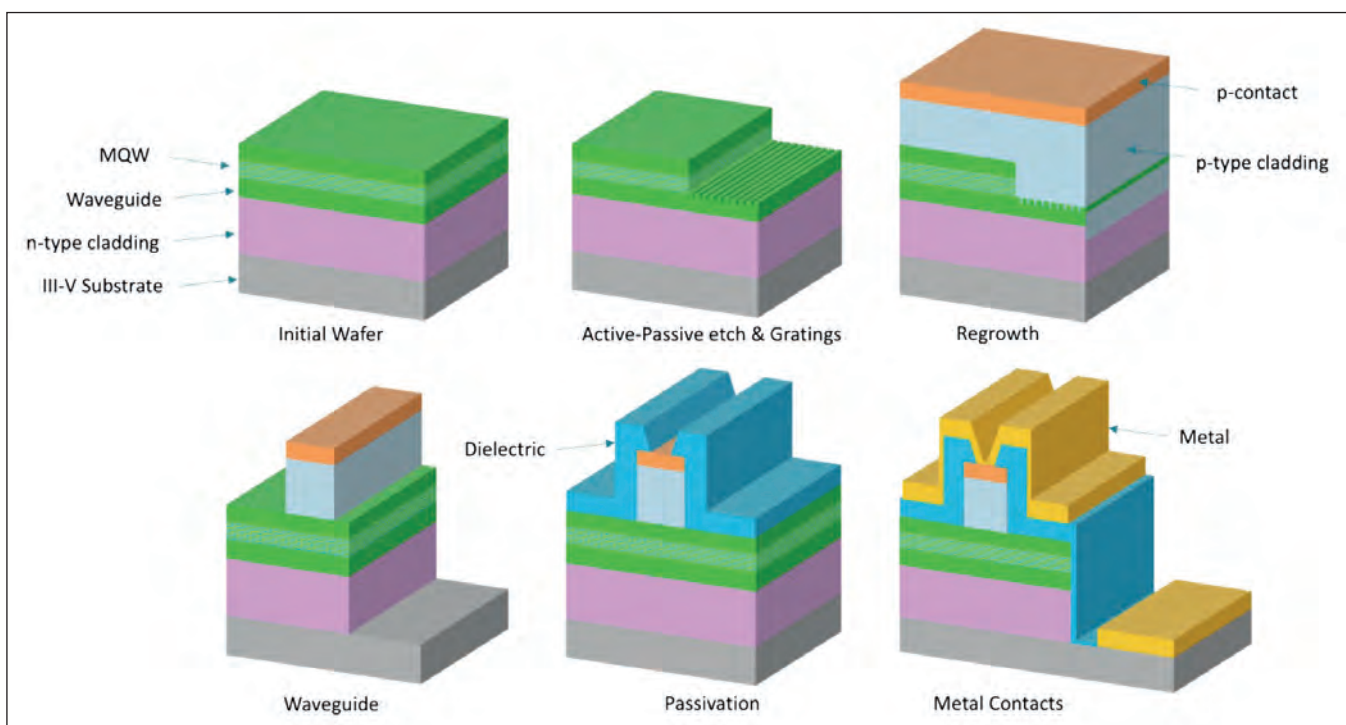

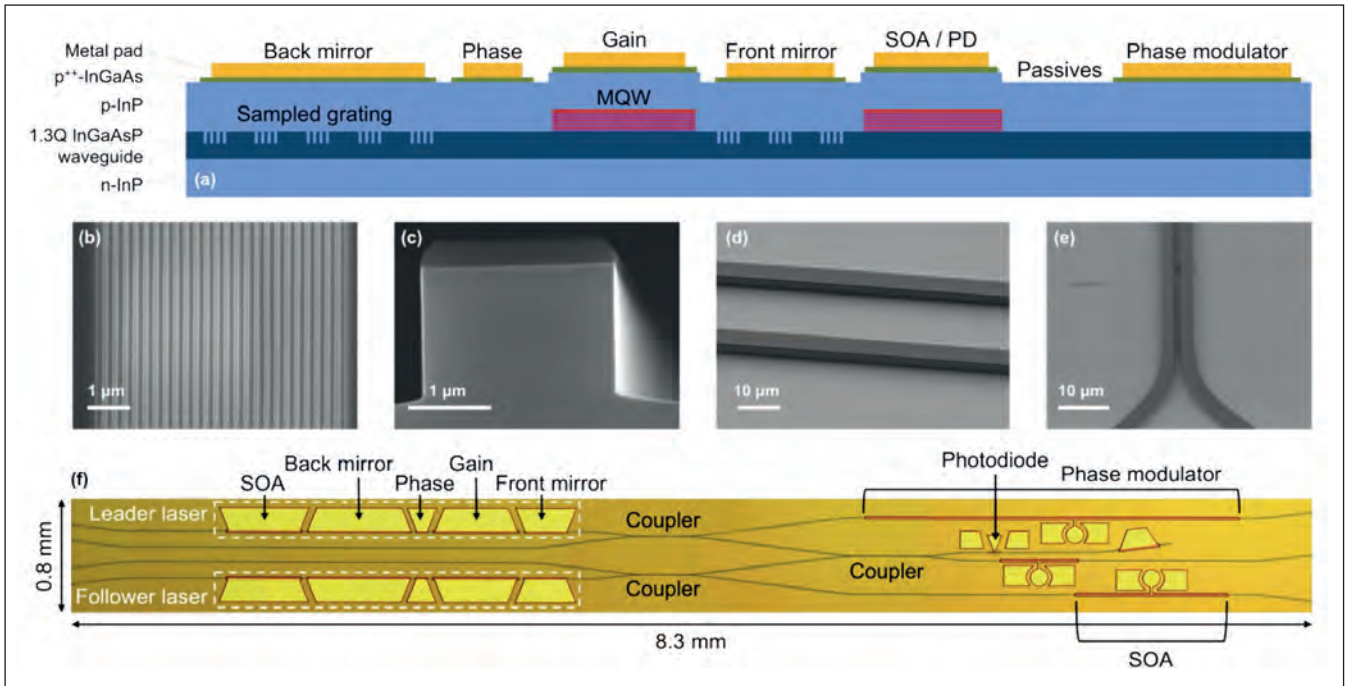

► Figure 2. (a) Simplified side-view schematic of an offset quantum-well PIC platform. Scanning electron microscopy images of (b) the top-view of fabricated gratings for the sampled grating distributed Bragg reflector (SGDBR) lasers, (c) cross-section of a fabricated ridge waveguide, (d) plan-view of two parallel waveguides, and (e) plan-view of a directional coupler with a 1 μm gap between the waveguides. (f) Top-view optical microscope image of a fully fabricated CO₂ lidar PIC.

grating distributed-Bragg-reflector (SGDBR) lasers, which provide leader and follower lasers for the active sensor. These lasers combine a gain section for generating photons with a back SGDBR mirror, a front SGDBR mirror, and a phase tuning section. As the sections of the laser are electrically isolated, each can be addressed separately. In addition to providing gain for a laser, active sections may also be used to form: a photodiode, which operates under reverse bias; and a semiconductor optical amplifier, operating under current injection. The amplifier can compensate for passive waveguide losses and boost the PIC output power.

Images acquired with a scanning electron microscope reveal the various elements during the fabrication process (see Figure 2 (b) to (e)). Even with an optical microscope, it is possible to identify the various components of a PIC designed to sense CO₂ using lidar. This PIC, with a footprint of approximately 0.8 mm by 8.3 mm, employs passive waveguides and directional couplers to route optical signals and connect active and passive elements. After the leader laser is a directional coupler and a phase modulator, the latter of which stabilizes the laser. The follower laser is followed by a directional coupler and a semiconductor optical amplifier, incorporating a high-speed pad configuration that enables encoding of high extinction pulses. Directional couplers tap a fraction of the signals from the leader and follower lasers, routing the combination to a high-speed photodiode.

Our PIC-based CO₂ sensing architecture, illustrated in Figure 3, features a leader laser that is locked to the 1572.335 nm CO₂ absorption line by an absolute CO₂ reference cell. An integrated phase modulator, driven at 125 MHz, enables the use of a frequency modulation technique. Fed with an output signal, a mixer extracts an error signal, which is fed to a control servo for signal filtering and processing, and coupled to the phase section of the leader laser to realise locking. An optical phase-lock loop, leveraging the high-speed photodetector for beat-note detection, enables the follower laser to be offset-locked to the leader laser by +/- 15 GHz. The output of the follower laser is coupled to a semiconductor optical amplifier pulse carver, which aids generation of the desired frequency-stepped pulse train for gas sampling.

An illustration of the measured error signal and gas transmission for the absolute reference cell, measured using the leader laser, is shown in Figure 4 (a). We have measured stabilization over 30 minutes with a 1 second gate time, and compared performance with and without feedback to characterize the relative impact of the stabilization circuit (see Figure 4 (b)). Without feedback, the peak-to-peak frequency stability is typically 675 MHz and the frequency standard deviation 86 MHz. Introducing feedback delivers a tremendous impact, with measurements revealing a reduction in the peak-to-peak stability to 2.75 MHz and a fall in the standard deviation to 465 kHz.



YOUR QUANTUM COMPUTER,
LIDAR, SPECTROMETER,
LASER, RECEIVER...

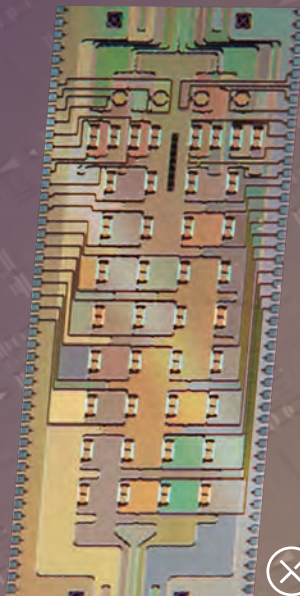

+
small PICs. Big Impact.

We provide performance: low loss PICs, high power resilient

We are trusted: reliable, efficient, established PDK

*We want to scale your business, FAST: scalable to volume,
rapid turn-around*



Once the leader is stabilized, the follower laser can be offset-locked to it. Our measurements, considering laser stability over 30 minutes with a 1 second gate time, show that the introduction of an optical phase-lock loop cuts the peak-to-peak frequency stability down from 1.36 GHz to 29 kHz, and the standard deviation from 181 MHz to 3.61 kHz.

Additional measurements of this PIC by our team show: that the optical spectra for the stabilized leader laser and for the follower laser can be offset by between 1-15 GHz (see Figure 4(d)); and an exemplary pulse can be generated with the semiconductor optical amplifier that follows the leader laser, demonstrating an extinction of 40 dB when swinging the drive current from 0-100 mA (see Figure 4(e)). We have also generated a frequency-stepped pulse train, enabling measurements of a CO₂ sample in a separate pressurized tube cell (results are reported in Figure 4(f)). Taken together, our set of measurements confirm the full operation of our PIC CO₂ lidar system.

Topographical lidar with GaAs PICs

As today's airborne topographical lidar systems tend to be built from commercial off-the-shelf components, such as bulk and discrete optics, this restricts their deployment to larger spacecraft or aircraft. One such example is NASA's Land, Vegetation and Ice Sensor, which is mounted on a Beechcraft B200 King Air. It will now come as no surprise that to enable deployment on small satellites, such as CubeSats, there needs to be a substantial reduction in size, weight and power – requirements that can be realised once again by turning to PIC technology.

For topographical lidar, the laser typically has a wavelength near 1000 nm, which is within a spectral range that has a relatively low atmospheric absorption and benefits from the existence of highly sensitive detectors. As this wavelength region requires the GaAs material platform, we have adapted our PIC platform for this III-V. We have fabricated a widely tunable laser, producing a centre wavelength near 1030 nm, which can be combined with diffractive optical elements for beam steering. Tuning the wavelength of the laser alters the angle of reflection from the grating element and effectively steers the beam, enabling wider surface coverage.

Our laser consists of a gain section, front and back mirrors for coarse wavelength tuning, and a phase section for fine wavelength tuning (see Figure 5 (a) for a side-view schematic, Figure 5 (b) for a top-view microscope image of the fabricated chip, and Figure 5 (c) for scanning electron microscopy image of a laser chip mounted on a carrier, with the metal pads wire-bonded to the carrier traces).

To tune the laser's output wavelength, we apply a current to the mirror and the phase sections. Coarse wavelength tuning is accomplished by tuning front and back mirrors, while fine tuning is realised with adjustment to the phase section. Our measurements show eight different lasing output spectra overlaid, demonstrating approximately 22 nm of coarse wavelength tuning (see Figure 6 (a)), and the use of the phase section for finer wavelength tuning (see Figure 6 (b)). We have also produced contour plots, which show the laser wavelength as a function of front and back mirror tuning, and demonstrate the full tuning capability (see Figure 6 (c)).

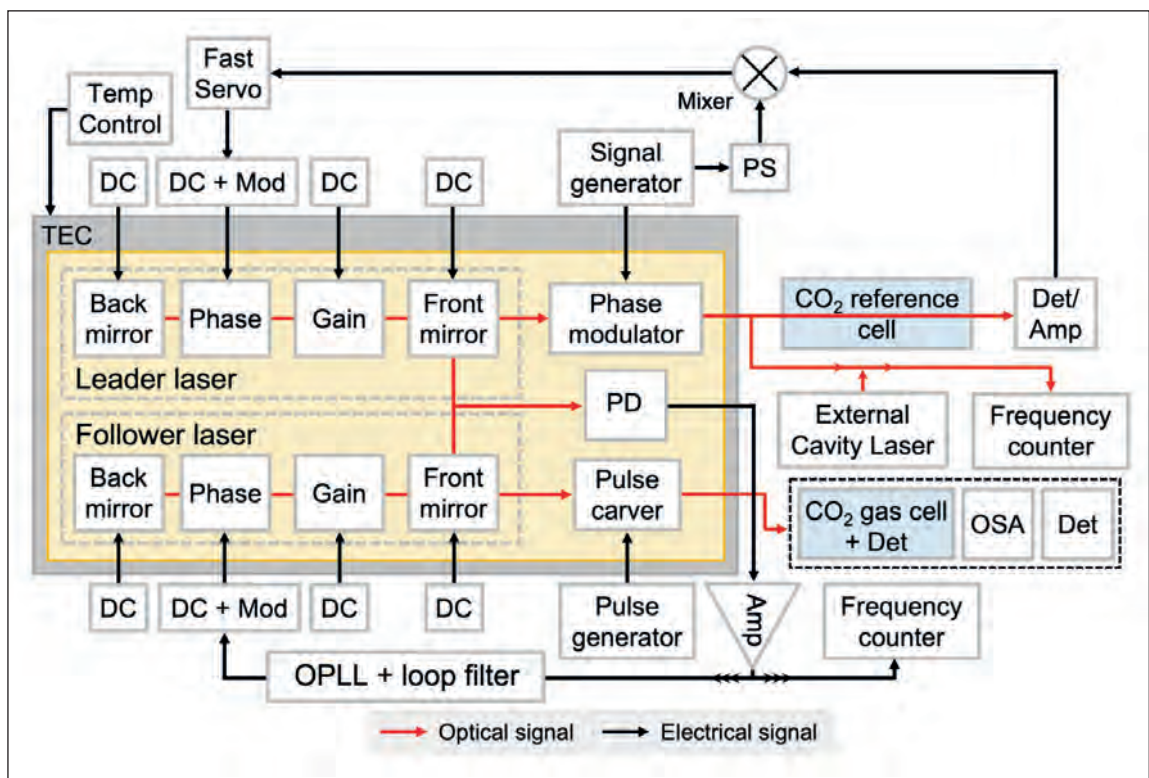

► Figure 3. PIC remote lidar CO₂ sensing architecture and test schematic.

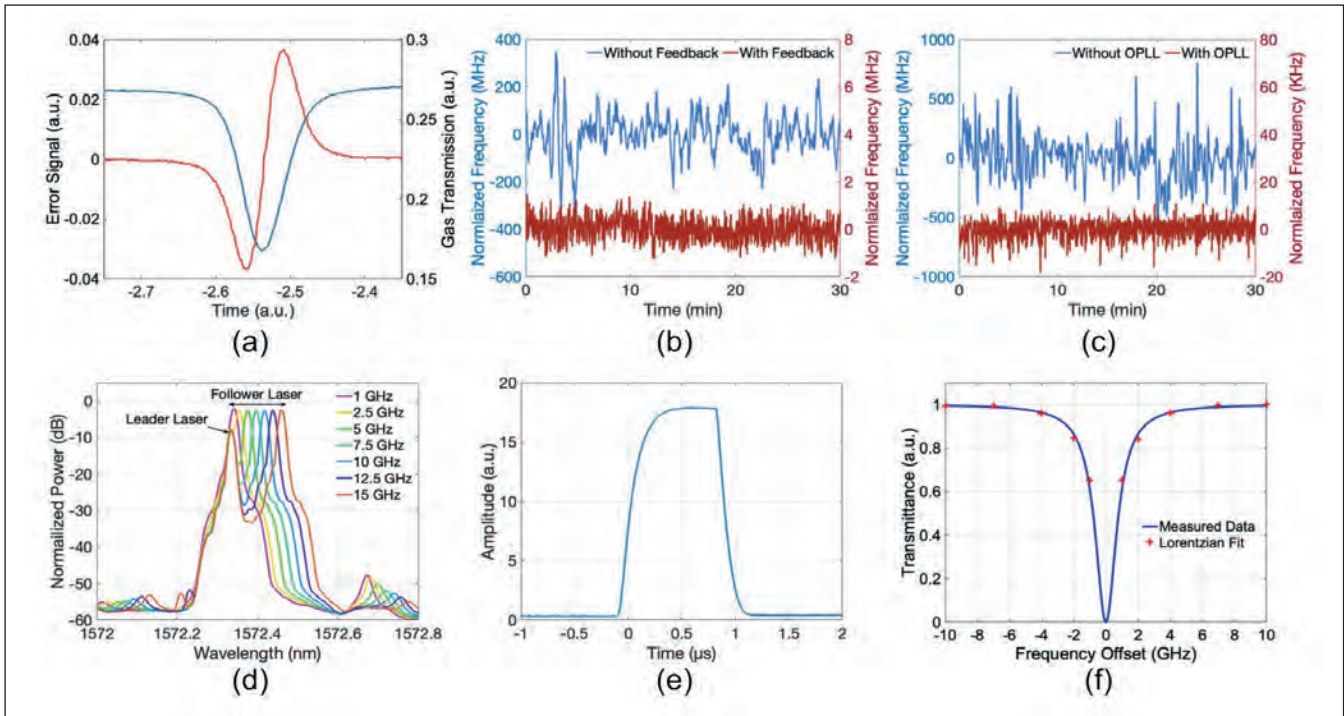

► Figure 4. (a) CO₂ reference cell absorption and the frequency-discriminating error signal used to stabilize the leader laser. The reference is a tube pressurized with CO₂. (b) Beat-note between the leader laser and an external cavity laser with and without feedback to the leader laser phase section. (c) Beat-note between the leader and follower laser with and without an optical phase lock loop (OPLL) engaged. (d) Overlaid spectra measured from the leader and follower laser as the follower laser is tuned from 1-15 GHz offset. (e) Exemplary 1 μs pulse generated by sweeping the bias on the semiconductor optical amplifier from 0 mA to 100 mA. The pulse rise time is 262 ns and the fall time is 169 ns. (f) Measured absorption of a CO₂ test cell along with a Lorentzian fit. The full-width at half-maximum (FWHM) of the fit is 1.6 GHz.

We have also investigated the capability of a semiconductor optical amplifier to increase the output power produced by the PIC (see Figure 6 (d)). For a conventional laser, without a semiconductor optical amplifier, output power is just above 35 mW at a drive current of 100 mA. For that drive current, when an equivalent laser is combined with a semiconductor optical amplifier biased at 100 mA,

total output power exceeds 75 mW (see the red curve in Figure 6 (d)).

Our two PIC platforms developed for space and airborne lidar – the InP PIC platform for active sensing of atmospheric CO₂ and the GaAs PIC platform for topographical lidar – highlight the promise of this technology for slashing the size,

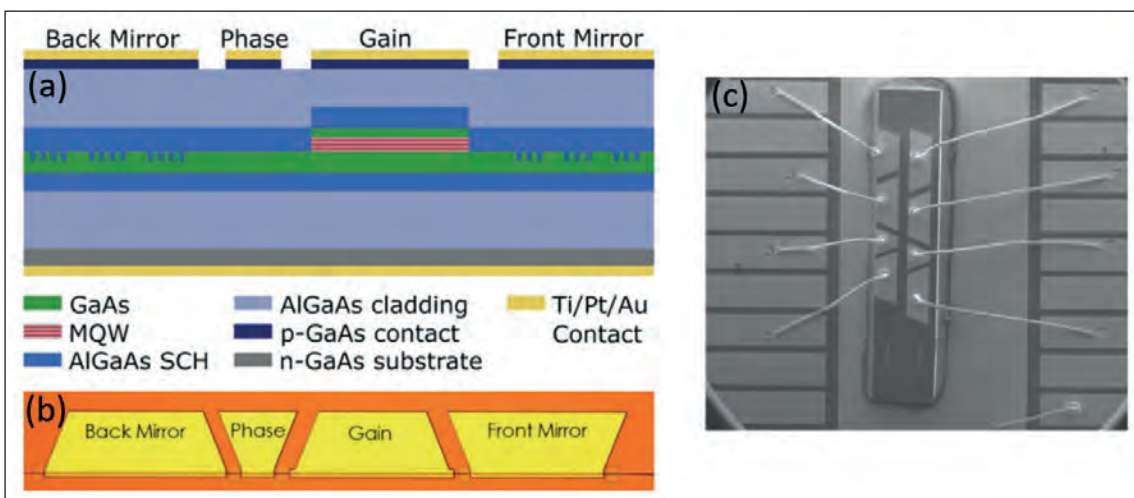

► Figure 5. (a) Side-view schematic of GaAs-based widely tuneable laser, (b) top-view optical microscope image of a fabricated laser, and (c) top-view scanning electron microscopy image of mounted and wire-bonded laser chip.

► Figure 6. (a) Overlaid spectra illustrating a 22 nm tuning range, (b) fine wavelength tuning with phase section, (c) contour plot showing wavelength as a function of front and back mirror currents, and (d) power output as a function of current with and without amplification.

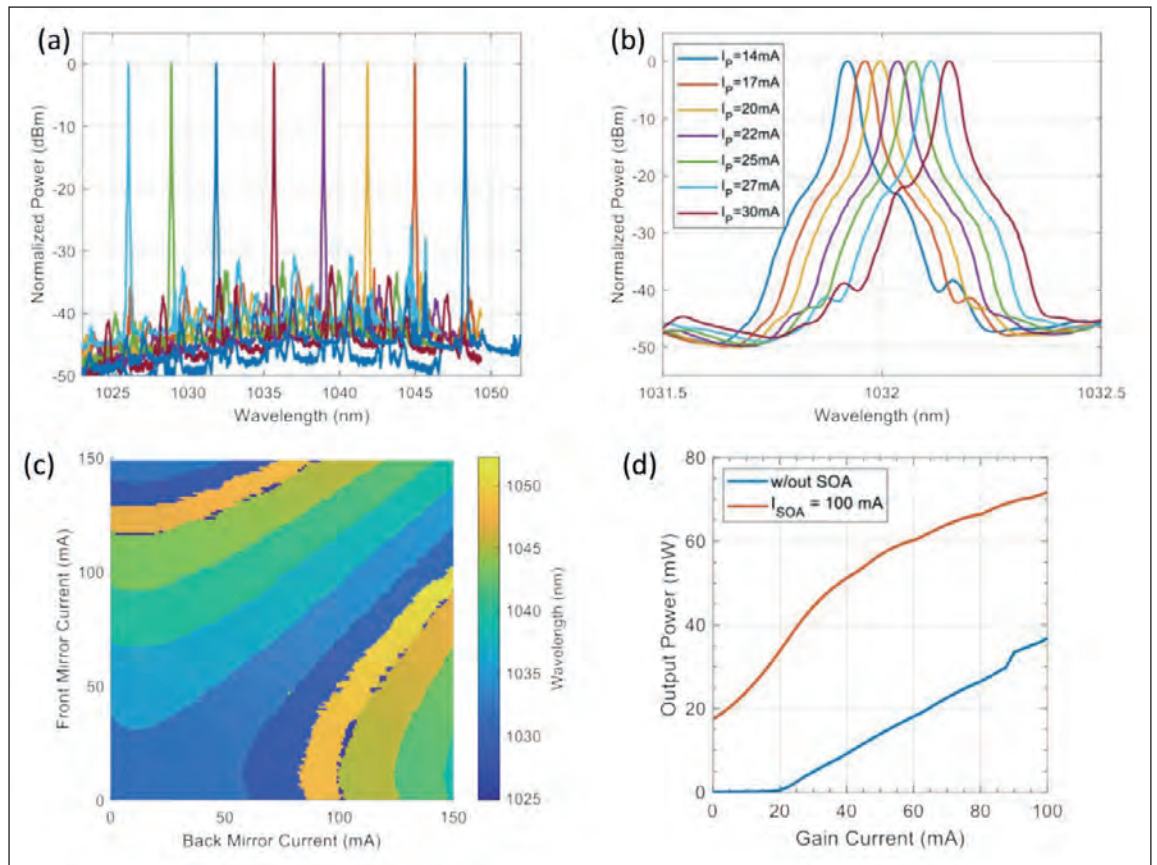

weight and power of systems serving these applications. Armed with these merits, these systems should see an increased frequency of deployment on small space platforms. To further this, in the near term we shall deliver hardware to our collaborators at NASA, so that they can perform their own sensing experiments in a laboratory setting. In conjunction, we will direct efforts at realising closer electronics integration, as this could lead to even lighter, smaller and more frugal systems. Beyond this, our plans include undertaking some space qualification, such as radiation testing, through

ongoing collaborations, and working with NASA to bring our technology to the next level of technology readiness – this is considered an ‘instrument programme’.

● The authors acknowledge funding support from NASA, technical contributions from Joseph Fridlander, Shannon Lee, Mark Stephen, Jeffrey Chen, Kenji Numata, Stephan Kawa, Fabrizio Gambini, Guangning Yang, Michael Krainak and Larry Coldren, and technical discussions with Parminder Ghuman and Amber Emory.

FURTHER READING

- H. Zhao *et al.* “High-Power Indium Phosphide Photonic Integrated Circuits,” *IEEE J. Sel. Top. Quantum Electron.* **25** 1 (2019)
- H. Zhao *et al.* “High Power Indium Phosphide Photonic Integrated Circuit Platform” 2019 Device Research Conference (DRC)
- J. Fridlander *et al.* “Dual Laser Indium Phosphide Photonic Integrated Circuit for Integrated Path Differential Absorption Lidar” *IEEE J. Sel. Top. Quantum Electron.* **28** 6100208 (2022)
- F. Sang *et al.* “Integrated Photonics Technology for Earth Science Remote-Sensing Lidar” 2021 IEEE International Geoscience and Remote Sensing Symposium IGARSS (2021)
- V. Rosborough *et al.* “Monolithic Integration of Widely-Tunable DBR and DFB Lasers with One-Step Grating Formation,” in *OSA Advanced Photonics Congress* (2019)
- P. Verrinder *et al.* “Gallium Arsenide Photonic Integrated Circuit Platform for Tunable Laser Applications” *IEEE J. Sel. Top. Quantum Electron.* **28** 5 (2022)
- P. Verrinder *et al.* “SGDBR tunable laser on gallium arsenide for 1030 nm lidar applications,” 2021 27th International Semiconductor Laser Conference (ISLC), 2021.
- J. B. Abshire *et al.* “Measuring atmospheric CO₂ for the NASA ascends mission: The CO₂ laser sounder approach” *IEEE International Geoscience and Remote Sensing Symposium* (2012)

New Industry Roadmap Released

Integrated Photonics for Data and Telecom

Transforming digital
infrastructures with
integrated photonics

PhotonDelta Roadmap Launch

As the world becomes increasingly connected via the Internet, the demand for data continues to rise. Alongside increased usage, the digital population also continues to grow, with current estimates close to 5 billion users worldwide. So how will the data and telecom industry meet this exponential growth in demand?



Download the roadmap
www.photondelta.com/downloads

Other available roadmaps:



Agrifood



Automotive



Biosensing



PhotonDelta

Gateway to Integrated Photonics