



# COMPOUND SEMICONDUCTOR

CONNECTING THE COMPOUND SEMICONDUCTOR COMMUNITY

## RF Devices

SiGe pushing into the auto market

## Solar conversion

Pushing theoretical conversion limits

## Photonics

Exploring the Holy Grail of integration

## InP

Towards a terahertz

## LED

Record UV output on a single chip

## News

CPV faces competition

GaAs/Ge solar cell revealed

Collaboration yields sunny results

InN solar challenges now met

Improved broadcasting

## The exploding LED market



*Do you want to be ahead  
of the industry's roadmap?*

**AIXTRON**



## **Marathon production for the manufacture of As/P LEDs and Solar Cells on 2 inch to 8 inch Substrates**

AIXTRON supplies MOCVD systems equipped with automated wafer handling up to 8 inch enabling high throughput production at low cost of ownership.

Be ahead of the industry's roadmap and increase your throughput, device yield and quality with AIXTRON's deposition equipment.

The AIXTRON product range comprises R&D and production tools for compound, organic, or SiC materials and nanostructures.

ALD ■ AVD® ■ CVD ■ MOCVD ■ OVPD® ■ PECVD ■ PVPD ■ SiC CVD



**AIXTRON**

AIXTRON AG · Kaiserstr. 98 · 52134 Herzogenrath · Germany · [www.aixtron.com](http://www.aixtron.com)

push your   
**PERFORMANCE**



October 2009  
Volume 15 Number 7**Editor-in-Chief**David Ridsdale dr@angelbcl.co.uk  
+44 (0)1923 690210**Consultant Editor**Richard Stevenson PhD  
richardstevenson@angelbc.co.uk  
+44 (0)1291 629640**Publisher**Jackie Cannon jc@angelbcl.co.uk  
+44 (0)1923 690205**Account Handlers**Shehzad Munshi sm@angelbcl.co.uk  
+44 (0)1923 690215  
Tommy Beazley tb@angelbcl.co.uk  
+44 (0)1923 690222**Design & Production Manager**Mitchell Gaynor mg@angelbcl.co.uk  
+44 (0)1923 690214**Circulation Director**Jan Smoothy js@angelbcl.co.uk  
+44 (0)1923 690200**Subscriptions Manager**Debbie Higham dh@angelbcl.co.uk  
+44 (0)1923 690220**Commercial Director**Stephen Whitehurst stephen@angelbc.co.uk  
+44 (0)2476 718970**Directors**Stephen Whitehurst, Jan Smoothy  
Bill Dunlop Uprichard**Published by**Angel Business Communications Ltd,  
Hannay House, 39 Clarendon Road,  
Watford, Herts WD17 1JA, UK  
T: +44 (0)1923 690200  
F: +44 (0)1923 690201Angel Business Communications Ltd  
Unit 6, Bow Court, Fletchworth Gate,  
Burnsall Road, Coventry CV5 6SP  
T: +44 (0)2476 718 970  
F: +44 (0)2476 718 971

Compound Semiconductor is published eight times a year on a controlled circulation basis.

Non-qualifying individuals can subscribe at:  
£105.00/€158 pa (UK & Europe), £138.00 pa (air mail), \$198 pa (USA). Cover price £4.50.  
All information herein is believed to be correct at time of going to press. The publisher does not accept responsibility for any errors and omissions. The views expressed in this publication are not necessarily those of the publisher. Every effort has been made to obtain copyright permission for the material contained in this publication.

Angel Business Communications Ltd will be happy to acknowledge any copyright oversights in a subsequent issue of the publication.

Angel Business Communications Ltd  
© Copyright 2009. All rights reserved. Contents may not be reproduced in whole or part without the written consent of the publishers. The paper used within this magazine is produced by chain of custody certified manufacturers, guaranteeing sustainable sourcing.

US mailing information: Compound Semiconductor (ISSN 1096-598X) is published 8 times a year Jan/Feb, March, April/May, June, July, August/September, October, November/December for a subscription of \$198 by Angel Business Communications Ltd, Hannay House, 39 Clarendon Road, Watford, Herts WD17 1JA, UK. Periodicals postage paid at Rahway, NJ. POSTMASTER: send address changes to: Compound Semiconductor, c/o Mercury International Ltd, 365 Blair Road, Avenel, NJ 07001

Printed by: Pensord Press.  
ISSN 1096-598X

## LED droop: controversy rages on

As I write this, many of our community are preparing for their trip to the eighth International Conference on Nitride Semiconductors (ICNS), which will be held on the beautiful island of Jeju, off the south coast of Korea. If this meeting is anything like its predecessor in Las Vegas, it will be a great affair. That gathering in the fall of 2007 had a tremendous buzz about it, and provided a fantastic showcase for leading academic work and triumphs in industry. Let's hope for more of the same.

LED droop was one of the topics discussed in Vegas. At the start of that year Philips Lumileds claimed that it had uncovered the mystery behind declining LED output as the drive current is cranked up, and the company selected this conference to reveal its finding. The culprit, according to Lumileds, was Auger recombination, a non-radiative interaction between an electron, a hole, and a third carrier.

This talk and the subsequent paper have ignited a debate on LED droop that rages on to this day. The debate's central question is this: Auger, or not Auger? Lumileds has an ally in Osram, which believes that the form of Auger recombination may involve interactions with defects or phonons. On the other side of the fence sits Fred Schubert and his co-workers from Rensselaer Polytechnic Institute, who argue that electron leakage is to blame. Hadis Morkoç's group at Virginia Commonwealth University are thinking along similar, but distinctly different lines, and point the finger at poor hole injection.

Other researchers are now joining the debate, including a Korean team that is arguing that Auger can't be the cause. These researchers studied carrier rate equations, and thanks to some nifty mathematics, they reduce the number of coefficients to fit the equation down to just one (see this month's research review for details). Curve fitting the data with their experimental measurements led them to conclude that Auger recombination only plays a very minor role in the cause of droop.

Researchers joining the debate on the origin of LED droop should make for fascinating discussion at ICNS. The nitrides continue to confuse us, but that's no bad thing – it makes this family of materials a great field for research.

**Richard Stevenson PhD**  
Consultant Editor

*P.S. Last month I mentioned that USCSB poached Hiroaki Ohta from Rohm. This is incorrect - he actually went from Rohm to Kyoto University, before joining UCSB.*



# Take the lead with Evatec... the Thin Film Powerhouse

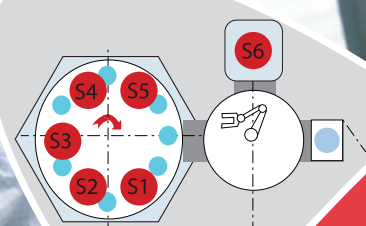
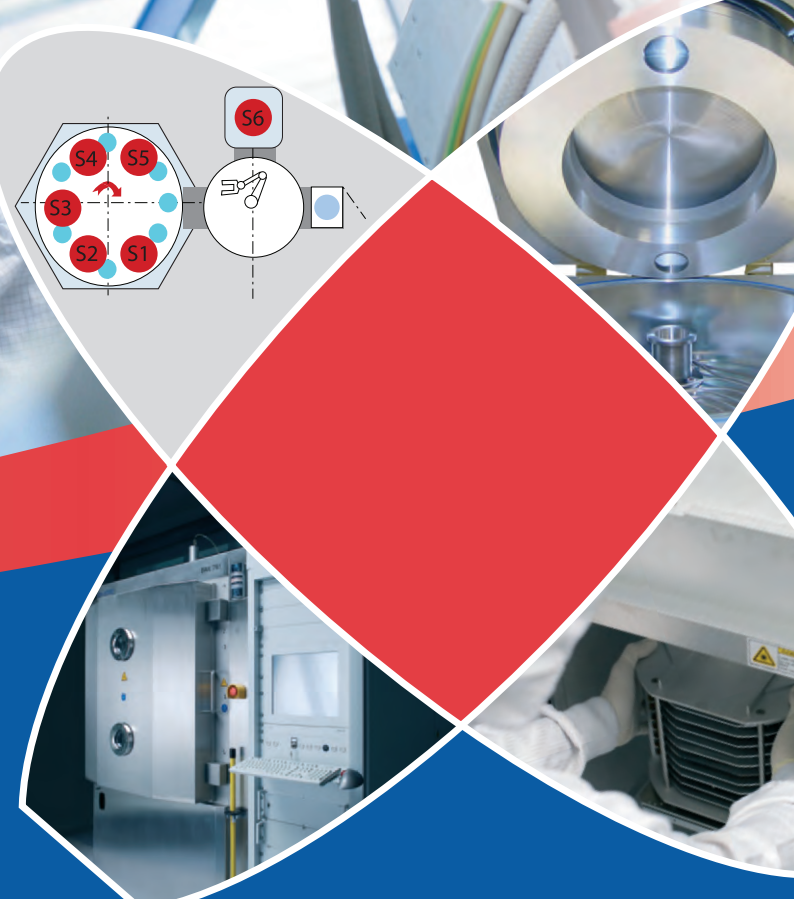

With the latest **PECVD**, **ICP** and **RIE** process know-how on our **Radiance** cluster platform, or the new cassette to cassette “**Autoload**” system for our **BAK** evaporators, ensure you power your way to the front in the race for highest yields and lowest production costs.

**Evatec Ltd.**

Lochrietstrasse 14, CH-8890 Flums, Switzerland

Tel: + 41 81 720 1080 info@evatecnet.com

[www.evatecnet.com](http://www.evatecnet.com)

**industry & technology**

**16 SiGe threatens GaAs auto monopoly**  
Shipments of GaAs chips for automotive radar will rise over the next few years thanks to the penetration of this technology into mid-price cars. However, sales are expected to falter by the middle of the next decade, due to tough competition from SiGe.



16

**21 Solar cell conversion efficiency**  
Increasing the conversion efficiency of triple-junction solar cells will help to cut the cost of this form of power generation. One approach to higher efficiencies is to push the bandgaps of the sub-cells towards the theoretical ideal.

**25 The Holy Grail of photonics integration**  
With hundreds of semiconductor laser designs that emit at 1550 nm or even 1310 nm, when will the industry agree on a common platform?

**33 InP propels towards a terahertz**  
DARPA is driving the development of ultra-high-frequency emitters and receivers based on InP HEMTs and HBTs that could lead to imaging systems that enable helicopter pilots to navigate in foggy, smoky and dusty conditions.

**38 The exploding LED market**  
Sales of LED-backlit TVs will rocket over the next five years, leading to domination of this market. What are the implications for LED chipmakers and MOCVD tool manufacturers?



38

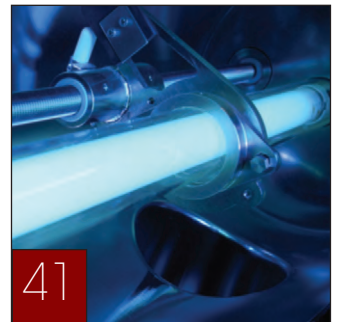

41

**41 Cranking up UV output**  
A partnership between Asif Khan's group at the University of South Carolina and its spin-off, Nitek, claim to have developed ultra-violet LEDs with a record output for a single chip.

**news**

**07 Dilute nitrides**  
Triple junction record

**10 Record solar cells**  
Improved broadcast

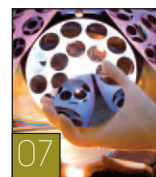

07



08

**08 Half a billion RFICs**  
GaAs on Ge solar cell

**12 Underwater talking**  
Downunder orders

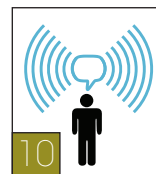

10



12

**09 Solar collaboration**  
Visible UV

**14 SiC impact**  
Metal sealed MFC



# Your premier choice for III-V and Ge substrates and related strategic raw materials.



VGF  
STRENGTH.  
PERFORMANCE.  
INNOVATION.

**AXT, Inc. is the only supplier in the world to offer materials for the inverted metamorphic, CIGS, and CPV Ge markets**

**We offer Ga metal for CIGS and Ge substrates for CPV applications**

**We also have GaAs and InP substrates as well as metamorphic and starting materials**

USA Headquarters  
4281 Technology Drive  
Fremont, CA, USA 94538

T: 510-438-4700  
F: 510-353-0668

E: [sales@axt.com](mailto:sales@axt.com)  
W: [axt.com](http://axt.com)

## Competition challenges CPV

The future of what was to be the world's largest concentrating photovoltaic power plant is now in doubt, after administrator PriceWaterhouseCoopers took over the running of its developer, Solar Systems.

Although PWC wants the Australian company to continue "on a reduced scale in order to restructure and sell the business as a going concern", it made two-thirds of Solar Systems' 150 staff redundant on September 11. Construction was due to begin on a 154 MW flagship project this year, but until investors are found it seems business will be limited to maintaining the 0.72 MW of power stations it operates. The news will be especially bad to III-V cell manufacturer Spectrolab, which had signed a \$100 million-plus agreement to supply 500,000 cell assemblies to Solar Systems.

With backing from both the Australian government and TruEnergy, Solar Systems appeared to have the right support to develop the 154 MW station. However, TruEnergy's parent China Light and Power (CLP) said that it was to take a HK\$346 million loss on its 20 percent stake in Solar Systems and has stated it does not wish to be the primary investor.

Explaining its move, CLP highlights fierce competition, both for credit and sales, in the crowded solar marketplace. Not only are start-ups facing difficulty gaining financing but they compete with companies who are cutting prices after the recent slowdown. It is likely that a similar situation could occur amongst the suppliers of based triple-junction solar cells, as their ranks swell and the technology surges ahead.

## JDSU becomes cell supplier

While production experience is a key weapon for III-V cell-making incumbents, other seasoned compound semiconductor manufacturers are joining the market, the latest of which is JDSU. The Milpitas, California, optoelectronic expert says that the same division responsible for producing its well-known optical communication lasers is now developing photovoltaic cells.

In its 2009 annual report the company groups its cells together with fiber-optic systems for delivering and measuring power. "JDSU has developed CPV cells to be available both as chips and in receiver assemblies, for solar power," it wrote.

JDSU says that the tens of thousands of photovoltaic power converters it has manufactured demonstrate the reliability of its cells. It acquired that technology in 2005 when it purchased Photonic Power Systems, and has since been offering it as a lightweight, interference-free, safe and resilient way of delivering electrical power. Now competing with New Mexico based Emcore in both optical communications and solar cell production, JDSU is the second major compound semiconductor name to crash the CPV market this year. The first was GaAs cellphone power amplifier manufacturer RFMD, which officially unveiled its collaboration with NREL in July.

## Cyrium licenses dilute nitrides

Companies with potentially revolutionary cell designs like the UK's Quantasol and Canada's Cyrium are claiming their slice of CPV revenues. Quantasol in particular marked out its intentions by revealing that it has licensed dilute nitride patents for triple-junction cell production. The crystal growth processes developed at the University of Houston should make cell manufacturing cheaper and simpler and improve efficiency, Quantasol says. Previously unexploited in III-V solar, dilute nitrides will allow each junction of the cell to be made with fewer quantum wells. With Quantasol's approach delivering the world record for a single-

junction cell in June, the industry will anticipate what it can do with triple-junction designs. Finance for solar projects remains tight, and Solar Systems' woes look like they could be a real setback to any hopes of proving the viability of CPV on a large scale. The EU Joint Research Center's Institute for Energy recent report suggests that just 17 MW of CPV power plants are currently installed worldwide, with 10 MW alone deployed in 2008. It offers hope with predictions that 30 MW will be installed in 2009 and 100 MW in 2010. It would not be surprising if the increasing numbers of III-V cell suppliers have to cut their prices.

## Spectrolab Recaptures Cell Record

Elevated competition can even be seen in Spectrolab's August 26 announcement that it has regained the record for the highest-efficiency triple junction cell. Beyond the irony that this coincided with Solar Systems' problems coming to light, it demonstrates a strong emerging transatlantic rivalry.

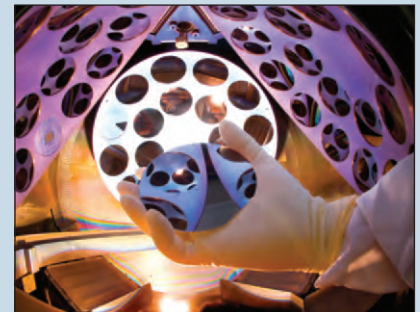

The Sylmar, California company's 41.6 percent conversion efficiency cells have overtaken the 41.1 percent achieved by Germany's Fraunhofer Institute for Solar Energy Systems in January this year. This marks a rapid acceleration in efficiency improvements, after the 40.7 percent record that Spectrolab achieved in December 2006 had only been pushed to 40.8 percent by the US National Renewable Energy Laboratories by August 2008.

The record may change hands again soon, as the Fraunhofer team, which is transferring its designs to compatriot commercial cell producer Azur Space, believes it can push beyond 42 percent. Rather than introducing novel technology, Spectrolab achieved its latest record by optimising the existing lattice-matched germanium/GaAs/GaN cells that it produces today in high volumes.

The company credits the record to multiple improvements in wafer processing that reduce the area of the cell shadowed by its metal contact grid, and improve series resistance. President David Lillington says that this "will be incorporated quickly and successfully into our production line".



## Peregrine ships half a billion

Peregrine Semiconductor Corporation has announced it has recently shipped its half-billionth UltraCMOS RFIC, a milestone which highlights the successful adoption and proliferation of the Company's disruptive UltraCMOS silicon-on-sapphire technology. Peregrine's UltraCMOS technology is a patented variation of silicon-on-insulator (SOI) process that combines industry-standard silicon CMOS circuitry with a highly insulating sapphire substrate, delivering the industry's highest RF performance in areas such as linearity, isolation, ESD tolerance, speed and switch settling time.

More importantly, UltraCMOS-based RFICs offer an environmentally friendly option to arsenic-based GaAs ICs which have historically been widely used in RF and wireless systems. With the global move toward 'green engineering' and reduction of hazardous substances (RoHS), UltraCMOS SOS devices are poised to offer engineers and manufacturers alike a simple, responsible solution for the next-generation designs demanded by the environmentally conscious consumer.

For years, engineers designing for personal communications devices such as cellular phones and mobile digital assistants sought primarily to increase system performance while reducing size and power consumption. Today, however, electronics component

designers must also take into account emerging standards and regulations regarding waste, hazardous substances and recycling. This is especially the case with handheld electronics, where extremely high global volumes are creating significant disposal issues in the earth's landfills. The green technology movement has generated resolutions around the world aimed at banning or limiting hazardous substances found in consumer electronics. In particular, gallium arsenide (GaAs) has been classified in the U.S., EU and Japan as a toxic compound and dangerous for the environment.

"With current worldwide sales of approximately 1.3 billion units per year, cellular handsets have become not only technology, business and lifestyle drivers but also a leading contributor to eWaste," stated Jim Cable, president and CEO of Peregrine Semiconductor Corp.

"We believe that by providing a performance advantage with our UltraCMOS technology and by offering systems designers an alternative to arsenic-based RFICs, we are doing our part to help our customers and the environment," he added. Peregrine, which has offices and a sales support network around the world, is also actively developing corporate programs toward the awareness of eWaste and electronics recycling.

## Deep SiGe vias

Tower Semiconductor and its subsidiary, Jazz Semiconductor have announced the availability of Deep-Silicon-Via (DSV) technology available in its 0.18-micron SiGe BiCMOS. The new offering provides a way to create a low-inductance ground required to reduce power consumption of power amplifiers (PAs). Unlike older Through Wafer Vias used primarily with smaller wafer sizes in GaAs-based technology, the DSV is optimized for silicon 8-inch wafer.

The DSV technology developed by Jazz utilizes existing equipment in its silicon CMOS wafer fabs and therefore can be scaled efficiently to high volumes without requiring complex thin wafer handling and processing. According to Strategy Analytics, power amplifiers in front-end modules of cell phones are expected to grow from 1.6 Billion units in 2009 to 2.5 Billion units in 2012.

"We continue to invest in foundry technology for the front-end module by enabling silicon solutions of components that have traditionally been built in GaAs. This new DSV technology is the latest offering in our Silicon Radio Platform that includes SiGe power amplifiers and SOI-based silicon switch technology," said Dr. Marco Racanelli, Senior VP and GM, RF and High Performance Analog Business Group at Tower and Jazz.

## IMEC introduces GaAs/Ge solar cell

IMEC announced a mechanically stacked GaAs/Ge multijunction solar cell. This is the first demonstrator of IMEC's technology to produce mechanically stacked multijunction solar cells, aiming at efficiencies above 40%. At the top of the stack is a one-side contacted GaAs top cell that is only 4µm thick and is transparent for infrared light. Its efficiency is 23.4%, which is close to the efficiency of standard GaAs cells. IMEC transferred this GaAs top cell onto a Ge bottom cell, creating a mechanical stack. In that stack, the Ge bottom cell is separately contacted. It has a potential efficiency of 3-3.5%, which is higher than Ge bottom cells in state-of-the-art monolithically stacked InGaP/(In)GaAs/Ge cells. IMEC, expects to show a first working triple-junction cell beginning of 2010.

This cell is a demonstrator of IMEC's technology to produce mechanically stacked, high-efficiency InGaP/GaAs/Ge triple-junction solar cells. This includes manufacturing world-class thin-film III-V cells and Ge bottom cells, and developing a technology to mechanically stack them. The expected conversion efficiencies are 1-2% higher than those obtained today with monolithic triple-junction solar cells (> 40% with concentrated illumination). The cells show an enhanced spectral robustness. Stacked solar cells combine cells made from different materials to capture and converse a larger part of the light spectrum than is possible with a single material.

Dr. Jef Poortmans, IMEC's Photovoltaics Program Director: "Mechanical stacks are



more complex to handle and interconnect. But they definitely offer a way to increase the conversion efficiency and energy yield of high-efficiency solar cells. And they also enable an efficient way to try and use new combinations of materials. For this technology, we profit from IMEC's expertise in 3D stacking, growing III-V layers, and solar cell processing."



## Collaborative research for solar growth

QuantaSol has exclusively licensed advanced materials growth technology from the University of Houston to make its manufacturing process simpler and cheaper, while further improving solar cell efficiency.

"We've already tested the benefits of using Houston's dilute nitride materials in the way we engineer quantum wells in our cells," said Keith Barnham, CSO and co-founder of QuantaSol. "The exclusive worldwide licence is a strategic move to ensure we maintain our performance advantage, and we will work with our colleagues in Houston to develop the techniques further in commercial production in 2010."

QuantaSol combines nanostructures, 'quantum wells', of two or more different alloys, in order to obtain synthetic crystals. The crystalline structure can be tuned during manufacture to overcome the absorption problems associated with current concentrator photo-voltaic (CPV) cell designs. The quantum well effect also greatly enhances the photovoltaic conversion efficiency, as already proven by its recent world record efficiency single junction device. Ultimately QuantaSol will produce highly efficient triple junction CPV devices in 2010.



The use of dilute nitrides will allow QuantaSol to reduce the number of quantum well layers it needs to introduce into each junction, while maintaining or increasing solar efficiency. This further reduces the thickness and manufacturing cost of its production devices.

"This is the first major collaboration QuantaSol has announced," said Chris Shannon, QuantaSol's new CEO. "It indicates just how close the company is getting to being able to produce very efficient devices in production quantities."

"We are excited to cooperate with QuantaSol in its application of the basic patents of Prof. Alex Freundlich on quantum well solar cells. These joint efforts will advance solar cell technology and help increase our use of renewable resources," said Alex Ignatiev, director, Center for Advanced Materials, and professor at the University of Houston.

## UV visible NIR range spectroscopy

CRAIC Technologies, an innovator of UV-visible-NIR microanalysis solutions for scientific laboratories, announces the Microspectra 10 UV-visible-NIR microscope spectrophotometer. This system is specifically designed to be added to the open photoport of any optical microscope to enable it to be used to acquire spectra of microscopic samples.

Depending upon the microscope's configuration, the Microspectra 10 is capable of UV-visible-NIR range spectroscopy by absorbance, transmission, reflectance and fluorescence. Applications are numerous and include quality control of LCD and OLED displays, vitrinite reflectance of coal and coke, thin film thickness measurements of photovoltaic cells and much more. Combined with CRAIC Technologies traceable

microspectrophotometer standards and sophisticated spectral analysis software, the Microspectra 10 is a powerful tool needed in any laboratory.

"CRAIC Technologies has been involved with UV-visible-NIR microanalysis since its founding. We have helped to advance the field of microscale analysis with innovative instrumentation, research and teaching.

The Microspectra 10 microscope spectrophotometer is a cost effective solution for a laboratory to begin microscale spectral analysis" states Dr. Paul Martin, President of CRAIC Technologies. "CRAIC Technologies microscope spectrophotometers are durable, easy-to-use and provide the highest quality data of microscope samples and microscopic areas of larger samples such as OLED displays."

## 8 Reasons to Work with Spire Semiconductor to Develop Your Next Optoelectronics Product...



- 1 Spire Semiconductor is a **complete compound semiconductor fabrication facility** dedicated to supporting its customers.
- 2 Spire Semiconductor has its own **MOCVD III-V and II-VI multi-wafer, multi-reactor** capabilities for high volume production requirements.
- 3 Spire Semiconductor has a **first-class compound semiconductor device fabrication facility** with class 100 cleanrooms.
- 4 Spire Semiconductor's engineering staff has **extensive experience** in material and device design, process development and testing.
- 5 **You can work directly** with Spire Semiconductor's engineers.
- 6 Spire Semiconductor can **manufacture your products** in volume exclusively for you.
- 7 As a pure play foundry, we do not compete with our customers.
- 8 Working with Spire Semiconductor will **keep you ahead of your competition.**

Edward D. Gagnon  
General Manager,  
Spire Semiconductor

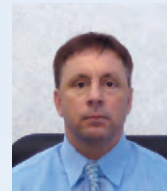

  
**Spire Semiconductor, LLC**

25 Sagamore Park Road, Hudson, NH 03051  
T 603.595.8900 F 603.595.0975  
[sales@spiresemi.com](mailto:sales@spiresemi.com)

## World record solar cells

Sunovia Energy and partner EPIR Technologies have announced that they have fabricated single-junction and two-junction cadmium telluride (CdTe) based solar cells that have far surpassed the long-standing world record open circuit voltage (Voc) for thin film CdTe solar cells. The Partners' single-junction and two-junction devices exceeded the highest Voc values ever reported publicly by research institutions on thin film CdTe solar cells (including NREL and others) by over 45%.

The results reported by the partners will enable the companies to create solar cells with much higher efficiencies than other CdTe-based solar cell technologies. Open circuit voltage has traditionally been the most difficult performance metric to optimize in CdTe solar cells and the Partners' CdTe-based (also known as II-VI materials) solar cells achieved open circuit voltages of 1.34 V and 1.75 V in the single-junction and two-junction configurations, respectively. The 1.34 V value in the single-junction configuration is more than 95% of the theoretical upper limit for the II-VI alloy used by the Partners.

In contrast, the highest reported Voc for a CdTe solar cell is 0.91 V, representing about 76% of the theoretical maximum for CdTe. By fabricating II-VI solar cells with open circuit voltages close to the theoretical upper limit for the materials utilized, the Partners have developed high efficiency CdTe-based solar cells, which will accelerate the push of clean solar-generated electricity towards grid parity.

The Partners recently announced the expansion of their pilot production facilities, and are working to complete the initial 100 MW of manufacturing capacity. Their proprietary cell manufacturing process requires substantially less space than competing solar technologies, and is scalable at a fraction of the previous cost.

According to Dr. Michael Carmody, Senior Director for Development of Photovoltaic Materials at EPIR Technologies, "These are by far the highest Voc measurements ever exhibited by a CdTe-based solar cell. There is no data in the literature that comes close to what we have achieved, and we believe that our two-junction device also represents

the first ever high efficiency monolithic, two-junction solar cell using CdTe or any other II-VI material."

Dr. Siva Sivananthan, founder and CEO of EPIR Technologies says, "Over the past 2 years, EPIR and Sunovia have collectively grown from 25 to almost 70 employees and will add many more manufacturing jobs as we commercialize this technology. These breakthroughs are a tremendous step forward for our national security and energy independence goals. I am tremendously proud of the team at EPIR, and am pleased to be partnered with such an outstanding group of professionals at Sunovia."

Carl Smith, founder and CEO of Sunovia Energy Technologies added, "In one of the most difficult economic climates in history, we have remained intently focused on our goals, and together we have grown rapidly. This new solar technology that Dr. Sivananthan's team has invented has far-reaching benefits that will not only positively impact national security, energy and our environment, but will also bring manufacturing jobs back to the States."

## Broadcasting improvements

TriQuint Semiconductor is enabling network operators to efficiently and economically meet the demand for broadband services with new solutions for cable systems, microwave radio and optical networks.

"Network operators are seeing substantial increases in radio, optical and cable network traffic because of the growing popularity of home and mobile data applications. Operators are looking for cost-effective ways to expand capacity while lowering operational expenses. Greener, more efficient systems that use less energy for amplification and cooling are especially appealing," observed Asif Anwar, Director, GaAs and Compound Semiconductor Technologies Service, Strategy Analytics.

"TriQuint is in a good position to take advantage of a projected 10% CAGR for point-to-point radio products and a cable infrastructure CAGR of 14% through 2013. The fiber optic IC market CAGR should more than double during this period while the emerging 40Gb/s segment will lead growth with a projected 78% CAGR

through 2013," he added.

TriQuint recently acquired cable TV and fiber-to-the-home (FTTH) RFIC expert TriAccess Technologies. TriAccess offers a 'triple-play' line-up of highly linear amplifiers with low power consumption for internet-video-voice services. Demand for TriAccess products has doubled as cable and telecom companies race to enhance networks for high-speed multimedia content delivery.

New TriQuint RFIC products developed by TriAccess Technologies meet the DOCSIS 3.0 based cable TV systems needs. These 'greener' products can reduce power consumption up to 50% and can cut overall PC board areas up to 30%. TriQuint's new TGA2807-SM is another DOCSIS 3.0 cable TV amplifier that can replace two conventional solutions.

TriQuint is advancing 3G/4G wireless network infrastructure with microwave radio

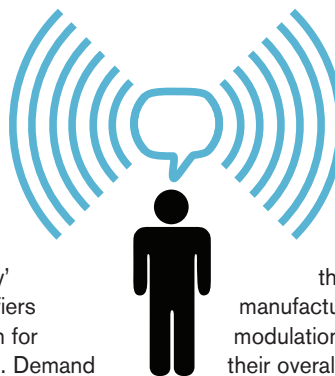

backhaul amplifiers including its TGA4531. The new amplifier does the work of two narrowband devices, covering the critical 17-24 GHz frequency range with a single device. Highly linear, the TGA4531 enables manufacturers to meet complex modulation requirements while reducing their overall bill of materials.

TriQuint enables high-speed optical networks with products like its TGA4943-SL—the market's first surface mount amplifier for 40Gb/s (gigabit per second) systems. In addition to offering surface mount convenience for easier assembly, the TGA4943-SL uses only about 50% the power of other solutions – just 2.1 Watts.

TriQuint was recently chosen by Huawei Technologies as a strategic partner for new optical network system development based on the strength of its technology and TriQuint's portfolio of green products that significantly reduce power usage. See these new devices at EuMW.





Imagination...

...engineered

Whatever your inspiration, STS takes your ideas further. As a key provider of plasma etch and deposition technologies for over 20 years, STS continues to deliver expert knowledge and advanced thinking to customers based on proven technology.

Whether you are an emerging or established enterprise we offer unrivalled experience, and unparalleled knowledge of our proven technologies turning your innovations into reality. Above all, we listen to our customers. Their success is all the inspiration we need. To find out more visit: [www.stsystems.com](http://www.stsystems.com)

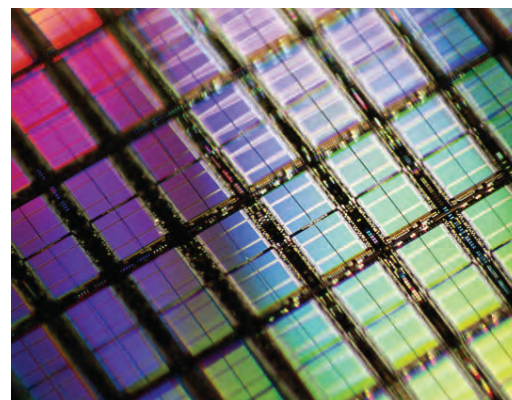

---

MEMS · COMPOUND SEMICONDUCTORS · PHOTONICS · ADVANCED PACKAGING · DATA STORAGE

THINK · INNOVATE · CREATE



SURFACE TECHNOLOGY SYSTEMS

# Powerful underwater laser communications

3S PHOTONICS, the French manufacturer of optical and optoelectronic components for telecommunication networks, and leading supplier of ultra-high reliability components for undersea optical networks today announced that it will unveil its Next-Generation 1996 SGP Series 980nm submarine-grade pump modules.

Capable of providing 600mW of ex-fiber optical power, the 1996 SGP Series is by far the industry's most powerful 980nm pump laser module available as of today for submarine optical networking applications. Its unparalleled performance and ultra-high reliability levels enable cost-effective design solutions for the deployment of Next-Generation 10G & 40G optical amplifiers into the submerged repeaters which are distributed along the submarine intercontinental cables.

This new pump module complements the current high power pump generation – 1994 SGP - under field deployment for more than 3 years and address new customer needs for increased power.

"NEC is extremely pleased to deploy 3S PHOTONICS submarine pumps that



contribute to the successful deployment of state-of-the-art submarine cable systems" comments Osamu Harada, General Manager of NEC's Submarine Networks Division. "New submarine systems will require much higher power levels and NEC has actively been collaborating with 3S PHOTONICS for the successful development and manufacturing of Next-Generation Submarine Cable Systems".

1996 SGP Series performance and ability to meet the extremely demanding submarine reliability requirements represents a key technological breakthrough for the submarine community, step-forward enabled by an ambitious development program

launched by 3S PHOTONICS, many technical results of which have already been published in various proceedings. State-of-the-art performance has been announced with optimized chip structures allowing to reduce internal losses down to record values as low as  $0.55 - 0.60 \text{ cm}^{-1}$  and to keep high external efficiencies. New designs also allow to keep low junction temperatures and injection current densities. Those results translate to the completion of the initial objectives of increasing operating power in excess of 600mW at the module level while meeting the stringent reliability requirements.

The construction of those pump modules is based on the renowned double-lens coupling platform which has proven its reliability since active components are field deployed for more than a decade in quantities over twenty thousand worldwide with no failures. Extremely long term aging tests have demonstrated the extremely high stability of the construction and typical expected end of life (EOL) power drifts are less than 2% over a 25-year lifetime.

"This platform is today the most deployed in the world so we can proudly and solidly refer to our submarine experience without the need to consolidate reliability information captured from a terrestrial platform as our competitors do", said Yannick Bailly, VP Marketing and Product Management at 3S PHOTONICS.

"Terrestrial information does not take into account the extended warranty periods requested by submarine customers and the imperative obligation of traceability for the product lifetime" he added.

3S PHOTONICS long-term strength in the area of high reliability products rely on well-mastered assembly technologies and processes, an extensive set of quality checks from kitting up to the final control before shipping, plus dedicated chip and module pedigree reviews.

"These are the key elements to guarantee to our customers the quality and reliability levels required by the submarine community", said Michel Privat, COO and VP Sales for 3S PHOTONICS. "This new product enlarges our product portfolio for submarine applications and strengthen our position of strategic supplier with regard to submarine system makers".

## Three orders downunder

Oxford Instruments Plasma Technology (OIPT) has just received a 3 system order from the prestigious new Melbourne Centre for Nanofabrication (MCN) in Australia. The systems, two Plasmalab System100 ICP380 tools and a Plasmalab System100 PECVD system, have been bought as part of the Centre's programme to equip their cleanrooms with state of the art instrumentation for nano and micro scale fabrication.

Oxford Instruments has a reputation for working with and equipping many renowned universities and research institutes throughout Europe and USA. That fact and the flexibility of OIPT's tools were important criteria in MCN's decision to choose OIPT as a strategic partner. The MCN is the Victorian node of the Australian National Fabrication facility (ANFF), a collaborative initiative between the Australian federal government, the

Victorian state government, CSIRO and major Victorian Universities.

MCN chose Oxford Instruments as the key provider for their etch, deposition and growth tools as OIPT offer proven, flexible and reliable tools, coupled with excellent global service and support.

MCN's ultimate purpose is to fill the gap in Australia for open access, multi-scale fabrication infrastructure, spanning a range of fabrication environments and materials.

Sales Director for OIPT, Mark Vosloo said, "OIPT prides itself in providing top end systems for academic research and recently equipped new cleanroom facilities for KAUST, Saudi Arabia, LBNL, USA and Southampton University, UK. We are delighted that MCN has also chosen OIPT Plasmalab systems for their new research centre."



# Indium Nitride solar solutions

Johnson Matthey, designer, manufacturer and distributor of highly reliable bulk and point-of-use hydrogen and nitrogen purifiers, recently shipped several palladium and getter purifiers that will enable further advancements in worldwide photovoltaic (PV) manufacturing.

"These latest shipments reaffirm our commitment to support the ongoing growth of the global electronics industry, particularly the rapidly expanding demand for PV applications. There is a great need for the best available technology to support this growth and Johnson Matthey wants to be the leading supplier of gas purification products," said Stuart Bestrom, Sales Manager for Johnson Matthey's Gas Purification Technology (GPT) group.

Bestrom said palladium membrane technology is preferred by PV and semiconductor fabs for use with the compressed hydrogen supply common in Asia and particularly in China.

"Purification of compressed hydrogen is challenging because it has ppm (parts per million) levels of oxygen, hydrocarbon and nitrogen impurities that are difficult to remove using catalytic or getter purifiers.

Customers have reported premature breakthrough and shortened lifetimes with regenerable and heated getter purifiers and this maintenance means increased cost-of-ownership," explained Bestrom.

"Our palladium purifiers remove these ppm-level impurities (O<sub>2</sub>, H<sub>2</sub>O, CO, CO<sub>2</sub>, N<sub>2</sub> and THC) without affecting lifetime, yet still provide outlet purity less than one ppb (parts per billion). That's why our purifiers are the ideal solution for compressed hydrogen applications."

Bestrom reported that a major U.S.-based manufacturer of thin-film solar cells and modules has installed several PSH-40 JM hydrogen purifiers at its fab in Shenzhen, China. They will be used to purify hydrogen used in amorphous silicon thin film manufacturing. Thin film solar panels are well suited for large-scale utility applications, including solar farms.

A major North American semiconductor company is using JM HP Series V-purge purifiers to support their diversification into indium nitride (InN) high-efficiency solar

cells. Bestrom said a purifier is installed on each MOCVD reactor to provide high-purity hydrogen during the growth process. HP Series purifiers use palladium membrane technology to allow selective diffusion of hydrogen in a compact system with continuous monitoring of operating status.

Incorporating Johnson Matthey's palladium membrane technology, the PSH Series hydrogen purifiers offer a cost-effective, single-system solution for hydrogen flow rates from 10 Nm<sup>3</sup>/hr to 60 Nm<sup>3</sup>/hr.

PSH Series purifiers also incorporate Johnson Matthey's patented V-purge technology to ensure quick start-up and rapid removal of hydrogen during power failure and other alarm conditions.

The PSH Series purifiers accept inlet gases of 99.9% or better purity and employ a catalytic pre-purifier to protect against oxygen impurity spikes. Designed for installation in Class I, Division II environments, they are PLC-controlled with a color touch screen HMI interface and provide continuous monitoring of purged electrical bays to ensure safety compliance.

"The China PV market is projected to grow 30 percent annually for the next several years, so JM expects to see ongoing orders for PV applications. We are the market leader in China where we have installed a number of purifiers," said Sean Peng, Asian Sales Manager of Gas Purification for the GPT group, which handles JM's GPT sales and service throughout China.

Yet another application for JM GPT hydrogen and nitrogen purifiers is in the production of silicon powder used to manufacture solar wafers.

A large Europe-based renewable energy company is using multiple HP Series V-Purge hydrogen purifiers and PureGuard heated getter nitrogen purifiers to eliminate oxygen and nitrogen contamination during powder production. The requirements of this venture need extreme purity.

Bestrom went on to add, "The company requires ppt (parts per trillion) purity to prevent even the smallest contamination that can compromise wafer quality. This process was developed in research and development and then transferred to a higher-volume production line."

## Metal-Sealed Digital Mass Flow Meters and Controllers



- ♦ Gas flows from 0-5 sccm to 0-100 SLM
- ♦ Fast response
- ♦ High accuracy, excellent repeatability
- ♦ Multi-Gas / Multi-Range, freely programmable ranges and gas types
- ♦ Analog and digital communication (e.g. RS232, DeviceNet)
- ♦ Surface mount options available (SEMI standard)

Innovation – Experience – Excellence



  
**Bronkhorst**<sup>®</sup>  
HIGH-TECH

I [www.bronkhorst.com](http://www.bronkhorst.com) - E [info@bronkhorst.com](mailto:info@bronkhorst.com)  
T +31(0)573 45 88 00 - F +31(0)573 45 88 08

# How SiC will impact electronics

Yole Développement updated its new markets & technological study dedicated to silicon carbide industry. Yole's report details major market metrics of the current and projected SiC device and substrate business, describing the targeted applications, the key players, the supply chain, the volumes and related market size of each segment. It gives the possible total accessible market for SiC electronics, highlighting the strengths and weaknesses of this technology over the current established silicon technologies. It describes the recent progress of device technologies as well as the new challenges offered by 4" and 6" substrates.

SiC challenges a \$2.6B silicon device market that is part of the overall \$12B Si based power discrete business (2008). Today the largest applications in potential revenue remain Power Supply PFC, UPS and Motor AC drives. Tomorrow, EV/HEV and inverters for PV installations will take the lead exhibiting higher CAGR (>15%/year).

However, cost issues slow down SiC penetration and Yole Développement only forecasts approximately 4% of the overall Silicon based power discrete market to be displaced by SiC in 2019.

"Low Voltage applications (< 1.2kV) are representing over 99% of today SiC device sales but Yole Développement anticipates a huge increase of Medium Voltage applications (1.2kV-1.7kV) in the next 2 years" says Dr Philippe Roussel, Project Manager at Yole Développement. High

Voltage apps will slowly appear from 2013-2014 along with technology improvement and cost reduction.

The entrance of SiC in the promising EV/HEV field has been postponed to 2014 as no switch has reached large volume production yet and car makers are still improving silicon IGBT technology. Moreover, most of the current or new entrant EV/HEV manufacturers are working on both GaN and SiC for their next gen inverters and no choice has been validated yet. In the 600-1200 V range, promising GaN technologies might threaten SiC. However, SiC industry maturity should protect it from frontal competition at least for the 2 next years. The total SiC substrate merchant market, including both n-type and S.I. has reached roughly \$48M in 2008. According to Yole Développement's analysis, it is expected to exceed \$300M in a decade. CREE stays ahead of the competition, but its relative market share on the open market is shrinking as II- VI, SiCrystal and several new entrants are gaining momentum in the substrate battle.

Yole Développement saw the emergence of 2 new entrants in SiC substrates in 2008: N-Crystals (Russia) and Xiamen Powerway Advanced Material Co., Ltd (China) who are manufacturing and marketing 2" and 3" SiC substrates 4H & 6H in both S.I. or n-type doping. Early 2009, another Chinese company, TankeBlue, announced impressive progress on scale up production of 3" SiC wafers, exhibiting micropipe density < 10/cm<sup>2</sup>. "This let us think that Chinese companies are becoming more and more

present on the market place proposing products with state of the art specs and competitive pricing", explained Dr Roussel.

Yole Développement assesses that the technical gap between yesterday's leaders and today's challengers is decreasing day by day. 4" wafers are now at full production at CREE and in final qualification phase at II-VI, Dow Corning and Nippon Steel. 6" is already announced by 2010. 150 mm wafers will definitely accelerate the cost reduction of SiC device manufacturing.

Transistor availability is the key condition to envision significant market growth. According to recent announcements from CREE, SemiSouth, TranSiC, Rohm or Mitsubishi, Yole Développement remains confident that 2010 will see first commercial volume offers in MOSFET, J-FET or BJT.

Once this condition is met, the SiC device industry will have to cut the cost to fit with client expectations. 2 parameters will have to be improved:

- SiC substrate \$/mm<sup>2</sup> cost
- SiC device manufacturing cost and yield, with a particular emphasis on epitaxy process.

The adoption of the SiC technology will also have to go through the severe qualification process of the industry (especially in the automotive sector). There, progress on reliability and robustness must fit the current silicon standards. If all conditions are passed, then Yole Développement can forecast \$800M market size for SiC devices in a decade from now.

## Metal Sealed Digital Mass Flow Controller

Bronkhorst High-Tech B.V. manufactures metal sealed mass flow meters/controllers, designed especially to meet the requirements of the semicon market as well as other high purity gas applications. The instruments feature high surface quality and are of modular construction with metal-to-metal seals that ensure long-term leak tightness. Now, as an alternative to traditional face seal fittings, optional downport connections (c-seal/w-seal) are offered to reduce mounting space, while facilitating installation and maintenance.

Metal sealed mass flow meters/controllers can be supplied in ranges starting from 0.1...5 sccm up to 0.6...100 slm (based on N<sub>2</sub>) or even higher on request.

Today's instruments are equipped with a digital pc-board, offering high accuracy, excellent temperature stability and fast response (settling time down to 500 msec). The main digital pc-board contains all of the general functions needed for measurement and control. The latest EL-FLOW design features Multi Gas / Multi Range

functionality, providing (OEM-) customers with optimal flexibility and process efficiency.

For the convenience of the customer Bronkhorst provides free and easy-to-use configuration software tools. In addition to the standard RS232 output the instruments also offer analog I/O. Furthermore, an optionally integrated interface board provides DeviceNet, Profibus-DP, Modbus-RTU or FLOW-BUS protocols.





2009 IEEE



# Compound Semiconductor IC Symposium

INTEGRATED CIRCUITS IN GaAs, InP, SiGe, GaN and OTHER COMPOUND SEMICONDUCTORS

October 11-14, 2009  
Greensboro, NC, USA



Sponsored by the IEEE Electron Devices Society  
Technically co-sponsored by the Solid State Circuits Society  
and the Microwave Theory & Techniques Society



## Chair's Message

On behalf of the organizing committee and the IEEE Electron Devices Society, the Microwave Theory and Techniques Society, and the Solid State Circuits Society, I invite you to be a part of the 2009 IEEE Compound Semiconductor IC Symposium (CSICS).

This year's symposium will be held October 11th – October 14th in Greensboro, NC.

CSICS has been going strong for 31 years. This year we chose to locate in what has become a hub of Compound Semiconductor research and manufacturing. I don't think that anyone at the 1979 meeting of the GaAs IC Symposium (the first) would have imagined that the largest manufacturer of GaAs in the year 2000 would be in the cellular (or in late 70's parlance... "portable") telephone business. Yet by 1990 it was clear that this was one of the most promising applications of this fledgling technology.

Through the years, the GaAs IC Symposium grew in size and breadth as GaAs integrated circuits spread into defense and commercial products. Corporate and academic programs

in GaAs research led to exciting advances in materials growth, device physics, higher integration levels and commercial applications. As GaAs technology matured, other III-V materials systems came into the mix. In 2004 in Monterey, CA, the Symposium changed its name to IEEE Compound Semiconductor IC Symposium (CSICS) to reflect the evolution of the III-V industry and the interests of its participants.

The CSIC Symposium is the preeminent international forum on developments in integrated circuits using compound semiconductors such as GaAs, InP, GaN, SiGe and other materials. Coverage embraces all aspects of the technology, from materials issues and device fabrication, through IC design and testing, high volume manufacturing, and system applications.

Several social events are planned that allow our attendees to interact in a relaxed setting. Events include the Sunday Evening Opening Reception, the Monday evening Technology Exhibition Opening Reception, the Tuesday

Technology Exhibition Luncheon, and the Tuesday Theme Party. This year's Theme Party has a distinct Southern flavor that I'm sure you will enjoy. We also offer daily breakfast and AM/PM coffee breaks Monday through Wednesday.

The IEEE CSICS is also offering a short course entitled "PA Design Fundamentals, Advanced Techniques and Technologies" on Sunday Oct. 11th, 2009. This course offers the student detailed instruction on circuit design techniques for various technologies as well as design examples by leaders in the compound semiconductor industry. In addition, we offer our "Primer Course" which is an excellent tutorial presented within the context of our Symposium technical program.

The Primer Course is offered on Sunday Oct. 11th, 2009.

We hope you will join us again this year as we're goin' to Carolina!

Marko Sokolich, Chair

### Questions or Concerns

Please contact: Lukrecija Lelong - Registrar  
Outside US +1 732 465 7810  
US & Canada +1 800 810 4333  
E-Mail: [csics09reg@IEEE.ORG](mailto:csics09reg@IEEE.ORG)







## SiGe threatens to weaken GaAs' grip on automotive radar

Shipments of GaAs chips for automotive radar will rise over the next few years thanks to the penetration of this technology into mid-price cars, such as the Volvo S80. However, sales are expected to falter by the middle of the next decade, due to tough competition from SiGe. **Richard Stevenson** reports.



**A**utomobiles come with more safety features than ever before. Cars are now equipped with additional impact bars that increase passenger safety when the vehicle is rammed from the side, and air bags that reduced the extent of injuries caused by a head-on collision. However, radar based technologies that can prevent crashes from happening are only just starting to take off. Until very recently, these systems that are based on a set of GaAs chips were only seen in luxury cars.

The lack of penetration into mid and low-priced cars is not because automotive radar is a new technology - it made its commercial debut in top-flight Mercedes-Benz models more than 10 years ago, where it offered an advantage over automotive cruise control. Radar detected any changes to the distance of the vehicle in front, and adjusted the speed of the car automatically. Automotive radar systems have evolved in the intervening years, and they now increase driver safety. Today's drivers receive flashes or audible warnings to make them aware of other vehicles nearby, and if they fail to react, a sequence of seatbelt tightening and harder and harder breaking brings the car to a stop.

The capability of modern automotive radar clearly makes it very attractive. However, expectations of significant commercial success have failed to materialize for several years due to three factors, says Asif Anwar, director of the GaAs and compound semiconductors technologies program at Strategy Analytics: a slow migration of automotive radar from luxury cars to mid-range models; a European outlawing of one of the frequency bands used for this technology in 2013; and competition with alternative technologies.

Up until recently, automotive radar was only fitted as standard in some models of the Mercedes-Benz S class, the BMW 7 Series, and the Lexus 430. "You also had the migration into lesser models, such as from an S class to an E class, as an optional extra," explains Anwar.

Penetration into the far larger mainstream market has been slow, due to a lack of cooperation within the automotive industry. According to Anwar, chipmakers were put under pressure to cut prices, in return they demanded commitments to high volume orders, and it took a long time for the two sides to strike a deal. But Volvo's recent promotion of the benefits of automotive radar suggests that widespread deployment of this technology into mid-price cars is happening now.

Over the last few years, automotive radar sales have also been hampered by a European Union ruling that will ban deployment of the 24 GHz variant in 2013. This move is to benefit radio astronomers, because signals produced from this form of radar - which emits over a wide band centered on 24 GHz - interfere with those that they are trying to detect.

Cars fitted with the 24 GHz variant of automotive radar are able to maintain an appropriate distance to the vehicle in front at relatively slow speeds in dense traffic. The 77 GHz narrow band cousin performs a similar function at higher speeds in situations where there is less traffic, such as on a motorway. However, efforts are now underway to develop a wideband radar technology replacement for the 24 GHz technology, which will operate over a band centered on 79 GHz. Outlawing 24 GHz radar has

hampered the up take of automotive radar, because it has left car manufacturers with the dilemma of whether it is the right decision to deploy this technology before the ban comes into force. This uncertainty aids the producers of alternative technologies, such as those based on cameras or lasers that can take market share from automotive radar manufacturers.

Despite all these problems, Anwar predicts that automotive radar shipments are set to grow substantially, and sales of GaAs MMICs will increase from \$54 million in 2008 to more than \$130 million by 2013. Many of these sales will be shared between the two leading chipmakers of this technology, TriQuint and United Monolithic Semiconductors. However, WIN Semiconductors could also benefit, because this foundry offers suitable processes for the manufacture of automotive radar chips. And Hittite also operates in this market, following its purchase of this product line from Northrop Grumman. "RF Micro Devices also have the process technologies, since the acquisition of Filtronic," adds Anwar, "so that's something to keep an eye on."

TriQuint's automotive design effort is based in Dallas, Texas, and originated from the acquisition of Infineon's GaAs business unit at the beginning of this decade. The first 77GHz GaAs MMICs designed with a



*European luxury car manufactures such as BMW have pioneered the deployment of automotive radar.*  
CREDIT: BMW

fully optical mm-wave process by Infineon were transferred to TriQuint's low cost and high volume 6-inch fab in Portland, Oregon in 2002, explains Markus Behet, a marketing manager for the company's automotive radar products. Since then, the company has continued to develop this chip set.

TriQuint is now ramping its 77 GHz chip set for a lead customer that is based in the US. The voltage controlled oscillator, transmitter and mixer are all manufactured with a low-cost HBT process in the company's Oregon fab. Low noise amplifiers and frequency doublers are fabricated by a fully optical, mm-wave 0.13  $\mu\text{m}$  low-cost PHEMT process, and the switch is manufactured with a vertical PIN process. A copper/tin bonded flip-chip approach that minimizes parasitic inductances at these millimeter-wave frequencies has been introduced in the last few years for the chip set.

*Bosch's third generation long range radar employs SiGe chips made by Infineon.*

"You place your flipped MMICs onto

the substrate, do a reflow cycle and then everything is connected," explains Behet. "You don't need to bond a large number of wires that are a potential source for performance degradation at these frequencies." The flip-chip approach creates interconnects with very low losses. Use of this method does necessitate that TriQuint's customers have access to flip-chip assembly capabilities – either in-house or at sub-contractors, but Behet says that manufacturers have readily accepted the innovative new process because of the advantages of fewer bond wires and a significant reduction of insertion loss for flip-chip components.

A typical lead customer will produce around 50,000 radar units in the first year with the potential for a few hundred thousand in years after. Automotive radar chip sets command prices of \$20-60 depending on volume and radar architecture, so TriQuint's lead customer could generate revenues of several million dollars per year for the company. This should provide a healthy income for the next few years, but further down the line success could be hampered by the rise of SiGe. "GaAs has a track record for 77 GHz auto radar chip sets but I see SiGe manufacturers looking actively at the market," says Behet.

Infineon Technologies is leading this charge, and last December it announced that its chip will go into Bosch's third generation of long-range-radar. This system, which has an improved range of up to 250 m, can be used to maintain a constant distance with the vehicle in front at high speeds, warn of collisions, support predictive brake assistance and eventually deliver automatic emergency breaking.

Wolfgang Lehbrink, Infineon's marketing manager responsible for the product marketing of radar components, claims that the company's fully automotive qualified

SiGe-technology is deployed in the best long-range radar in the world. "We have ramped up at the beginning of this year, and we're in volume production."

Lehbrink's claim for superior performance may raise a few eyebrows, because GaAs has the edge over SiGe in many RF products, and electronic devices made from GaAs are known to have low-noise figures and good switching performance. Lehbrink, however, believes that it doesn't make sense to make component-by-component comparisons, because GaAs and SiGe are two significantly different technologies. "You can't compare on a feature by feature level. What counts is the system performance. Infineon's highly integrated front-end chip improves this by minimizing the number of RF transitions as a result of integration of multiple blocks."

The system cost will also play a role in the success of this technology. However, it doesn't necessarily follow that the winning semiconductor technology will be the cheaper one.

Anwar, for example, believes that other factors will make a bigger difference than the cost of the technology, because the tens of dollars spent producing GaAs chipsets is very small in comparison to the price tag of automotive radar systems, which sell for several thousand dollars. Incidentally, the cost of producing an equivalent technology in SiGe is higher, according to Anwar, thanks to the low volumes of the market and the higher development costs of SiGe. The mask sets for this technology can cost several thousand dollars, although it is unlikely that Infineon has absorbed the full price for its SiGe development, because a significant proportion of its effort has been expended in projects sponsored by the German Federal Ministry of Education and Research.

Lehbrink's response to the question





of chip costs is markedly different. "What really matters is the system cost. That's where Infineon's SiGe transceiver, with its high integration, higher yield and significantly better reliability, gives the cost advantage to the sensor company." According to him, SiGe allows the migration of tasks onto the chip that were previously performed discretely. This ultimately drives down the total cost of the system. "And obviously mounting one or two chips on a board [with SiGe], is a much more cost effective way, than seven or nine chips, as it used to be in GaAs."

If Infineon is to wrestle a significant share of the automotive radar market from the manufacturers of GaAs chips, then it also has to convince potential customers that SiGe is the better product. GaAs, after all, is the incumbent technology, and many of its users may be reluctant to move away from a proven device technology. However, Infineon appears to have this issue in hand. It was a partner in an automotive radar project called KOKON that ran from 2004 to 2007, and this enabled the company to forge strong relationships with systems manufacturers Bosch and Continental and carmakers BMW and Daimler. "If you want to be successful in high-frequency radar, you have to have good system know-how linked to close cooperation with your customers," says Lehbrink. "Sensor development and production at 77 GHz is very different from taking off-the-shelf parts and putting them on a printed circuit board. Offering technology, design, test and qualification from one partner with long-term experience in high frequency technology is crucial to success in automotive radar applications."

Long-term success in any market also demands the continual development of better products. Infineon is well aware of this, and has just embarked on a three-year project called "Radar on chips for cars",

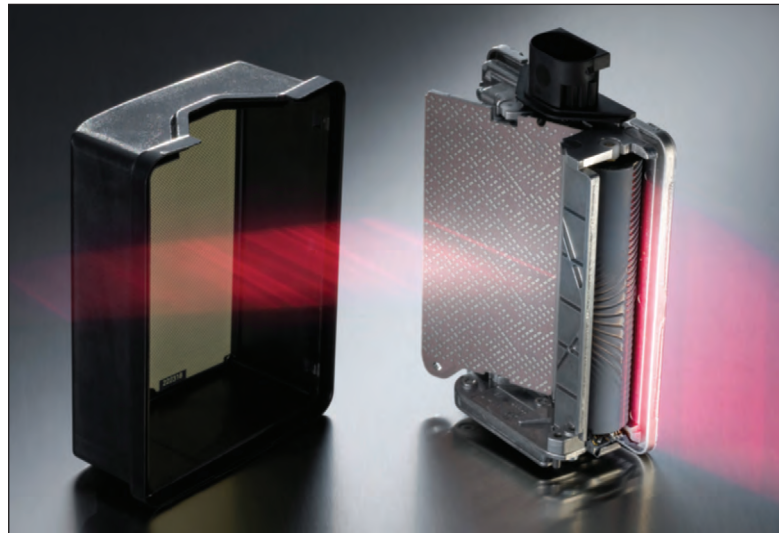

*Mercedes-Benz introduced Distronic, a form of automotive radar, in the late 1990s. The latest version, the Distronic Plus, is an option on the S-Class. CREDIT: Daimler*

which is partially funded by the German government. Collaborators in the project include BMW, Continental, Daimler and Bosch.

One of the goals of the project is lower cost automotive radar operating in the 77-81 GHz band. Turning to this far wider bandwidth enables an increase in spatial resolution. "If you look at the more bandwidth-hungry midrange and short-range applications for dense traffic, it is clear that you need more bandwidth and that will be provided by this frequency band," explains Lehbrink.

Infineon is clearly mounting a strong charge on the automotive market, and SiGe looks well poised for success. Anwar certainly thinks so. He predicts that the market for SiGe chips in automotive radar will rise from \$3 million in 2008 to nearly \$100 million in 2013, when the industry will have reached a tipping point. SiGe will then start to enjoy some significant uptick, mainly due to the activities at Infineon.

Lehbrink agrees with this view, and believes that virtually every automotive radar manufacturer will go to the effort of switching from GaAs to SiGe, which will be utterly dominant by 2015. If Anwar's predictions are correct, 10.6 million

automotive radar units will be deployed in cars in 2013. "On the one hand that's very, very strong growth. But on the other hand, if you consider that there are going to be 100-120 million new cars on the road in 2013, then that's still less than 10 percent of the market."

However, it is possible that the market could take off even more strongly if studies showed a significant decline in road deaths through the introduction of automotive radar, because this could herald the introduction of legislation that required this technology to be fitted to all new vehicles. This chain of events has already happened with tire pressuring monitoring, but this technology is far cheaper.

Even if governments don't intervene, it seems that GaAs is destined to enjoy some good years of increasing sales to the automotive radar manufacturers. But there is that nagging thought that it could have been so much better if penetration had occurred far quicker, and it appears that SiGe will be the long-term winner. So manufacturers of GaAs automotive radar chipsets must capitalize on the next few years, and then fight to maintain strong relationships with their customers in an effort to slow down declining revenues from this sector.

# III/V-Reclaim

GaAs  
InP

## The Cheapest Way to Excellent Quality.

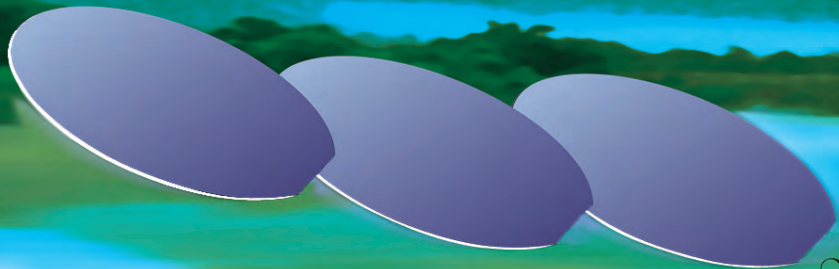

### III/V-Reclaim

Wald 10

84568 Pleiskirchen / Germany

Telefon: + (49) 8728-911093

Telefax: + (49) 8728-911156

E-Mail: [sales@35reclaim.com](mailto:sales@35reclaim.com)

Internet: [www.35reclaim.com](http://www.35reclaim.com)

- We recycle your GaAs and InP wafer (all formats and sizes)
- One and double side polished wafer
- Best surface quality for direct use in Epitaxy
- Backside thinning of fully structured wafer
- Thin wafer (60  $\mu\text{m}$ )
- Single wafer processing possible
- We buy used wafer and sell recycled wafer

## L A K E S H O R E H A L L E F F E C T M E A S U R E M E N T S Y S T E M S



10  $\mu\Omega$  to 200 G $\Omega$  resistances ■ 2 K to 800 K temperatures

Fields to 9 T ■ Easy sample access

Accommodate up to one 6-inch or four 1 cm<sup>2</sup> samples

QMSA<sup>®</sup> resolves individual carriers in multi-carrier devices

AC current for low resistance, high resolution measurement



# LakeShore<sup>®</sup>

575 McCorkle Boulevard Westerville OH 43082

Phone: (614) 891-2244 Fax: (614) 818-1600

[info@lakeshore.com](mailto:info@lakeshore.com) [www.lakeshore.com](http://www.lakeshore.com)

## RABOUTET S.A.

Manufacturer of Molybdenum.

Components for MBE.

Specialized Cleaning  
& Degassing available.



### RABOUTET S.A.

250 Av Louis Armand

Z.I Des Grand Prés

F-74300 Cluses France

Tél : 33 (0)4 50 98 15 18

Fax : 33 (0)4 50 98 92 57

E-mail : [info@raboutet.fr](mailto:info@raboutet.fr)

<http://www.raboutet.fr>





# Approaching the frontier of solar cell conversion efficiency

Increasing the conversion efficiency of triple-junction solar cells will help to cut the cost of this form of power generation. One approach to higher efficiencies is to push the bandgaps of the sub-cells towards the theoretical ideal, which is approach that we have adopted at **Fraunhofer ISE, says Frank Dimroth, Wolfgang Guter, and Andreas Bett.**

**T**he conversion efficiency of a solar cell is an important quantity in photovoltaics (PV). This is because the efficiency eventually defines the amount of electricity generated per area, determines the size of the land needed for PV installations, and ultimately sets the cost of solar electricity. Doubling the efficiency of a solar energy system reduces the cost per kWh price by more than a factor of two.

But, of course this is not the full story. Today's highest efficiency solar cells are made of III-V compound semiconductors and the manufacturing cost of these devices is approximately 50 times higher than for a state-of-the-art silicon solar cell. Even at 41% efficiency these solar cells will never become competitive with today's flat-plate silicon based PV modules. The energy produced by a III-V flat-plate module would simply be too expensive.

However, scientists have found a way to get around this bottleneck and still benefit from the extremely high efficiencies by turning to concentrating optics. In

high-concentration PV systems sunlight is collected from an area 500 – 2000 times larger than that of solar cell (see Fig. 1), which only covers a very small fraction of the module area. This slashes the amount of solar cell material needed and cuts cell costs significantly, assuming that the optics and the mandatory tracking units can be produced at low enough cost.

In fact, solar cells costs typically account for less than 10 percent of the total cost of high-concentration PV systems. In this case the benefit of a high efficiency can overcompensate the drawback of significantly higher material costs. Due to their unparalleled performance multi-junction solar cells made of III-V compound semiconductors are the product of choice for this application.

Fraunhofer ISE has a long tradition in the development of these high-efficiency solar cells and concentrator systems<sup>[1]</sup> and this January it achieved a new record in solar electric conversion efficiency of 41% at 454 suns (1 sun

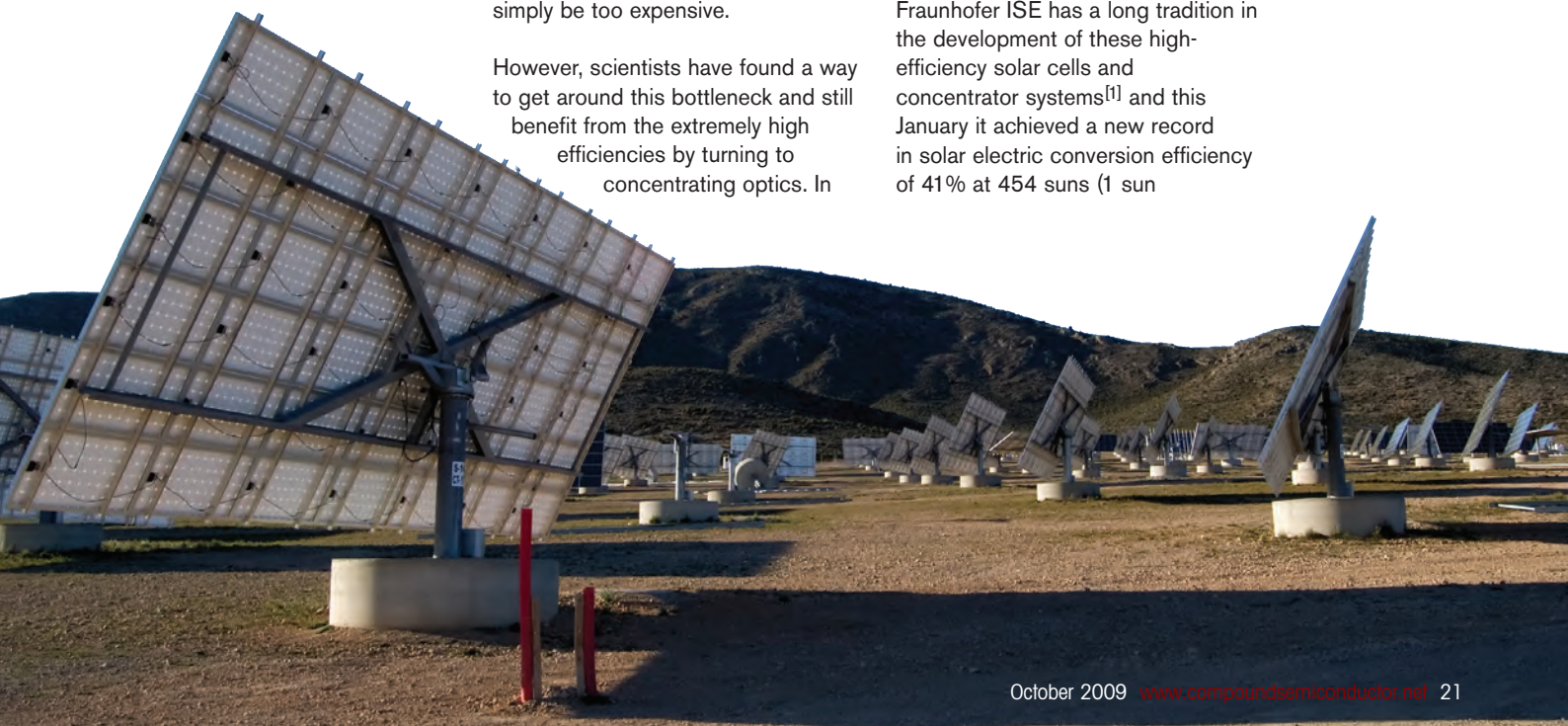
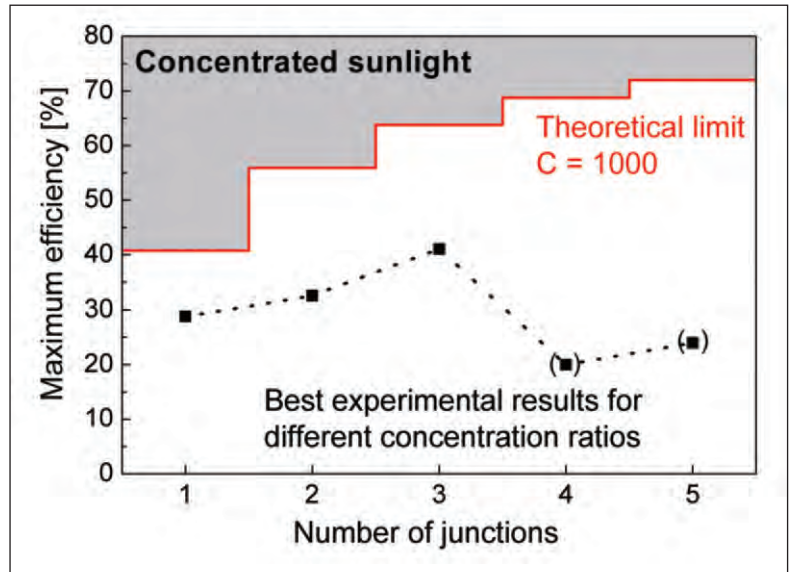
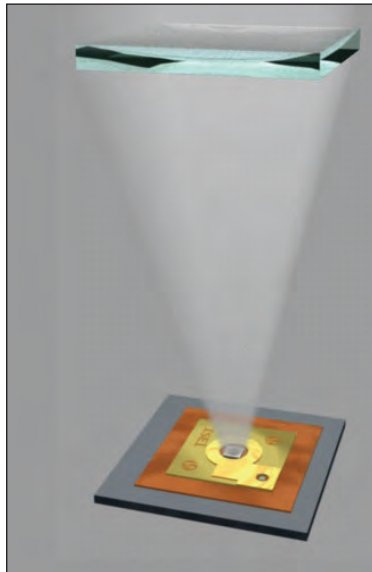

Figure 1: Right

Figure 2:  
Far right



corresponding to an intensity of 1000  $W/m^2$ ). Spectrolab has since raised the bar even further to 41.6 percent.

The conversion efficiency of a solar cell made of a single semiconductor material such as silicon is limited due to two reasons: long wavelength photons are transmitted through the structure and carriers generated by short wavelength photons quickly thermalize to the band edge, losing part of their energy by the generation of lattice heat.

These two fundamental losses limit the theoretical conversion efficiency of a solar cell made of a single semiconductor material to 40.8 % But these losses can be reduced i.e. through the use of several pn-

junctions made of semiconductors with different bandgap energies stacked on top of each other. In this case short wavelength photons are converted more efficiently by a first high bandgap cell and longer wavelength radiation is transmitted to an underlying second pn-junction which can again be followed by further lower bandgap subcells in the same way. Fig. 2 shows the theoretical conversion efficiency for such a multi-junction stack calculated for an ideal combination of bandgap energies and at a concentration of 1000 suns (corresponding to 1000 times  $1000 W/m^2$  incident intensity). The maximum efficiency increases to 55.9% for a dual-junction configuration to 63.8 % for an ideal triple-junction solar cell. The global

efficiency maximum is achieved for an infinite number of pn-junctions but one can also see from Fig. 2 that the benefit of adding more subcells decreases with the number of junctions and at the same time the complexity of the solar cell device increases significantly.

In fact every subcell in a multi-junction solar cell typically exists of approximately 6-10 individual layers forming the emitter and base, as well as surrounding barrier layers and the tunnel diode for the series interconnection of adjacent subcells. Today the highest efficiencies are reached for solar cells having three pn-junctions. An example of the complete layer structure of such a device is shown in Fig. 3.

below left and right: Figure 3

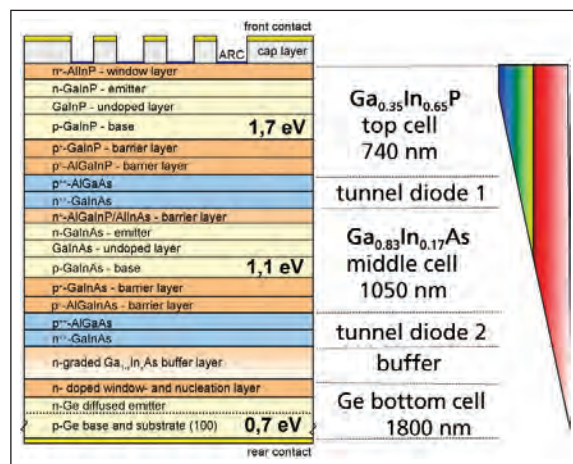
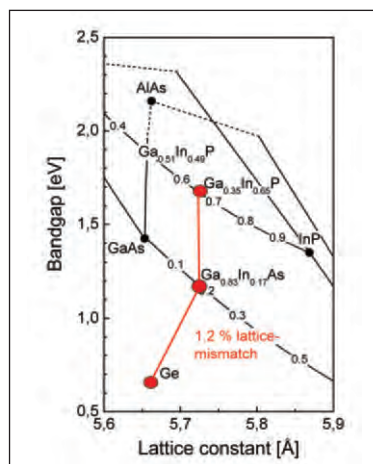

In the future it is well possible that devices with four or more junctions will show better performances. However, this requires all the layers to be optimized and to show excellent material quality. In fact material quality is a key requirement for achieving high solar cell conversion efficiencies, which explains why III-V compound semiconductors have been more successful than multi-junction cells made of polycrystalline or amorphous materials.<sup>[2]</sup> Defects in the active region of a solar cell lead to non-radiative recombination of minority carriers and



reduce the voltage as well as the current of the device. For this reason it was believed for a long time that high efficiency solar cells need to be built from semiconductors with the same lattice-constant to avoid the formation of defects due to lattice relaxation.

The global efficiency maximum for a triple-junction solar cell is found for a bandgap combination of 1.74, 1.17 and 0.70 eV. Germanium with a bandgap of 0.67 eV turns out to be a good candidate for the bottom junction but unfortunately for the middle cell there is no lattice-matched semiconductor with a bandgap between 0.67 and 1.41 eV (see Fig. 3 left). Therefore, until recently the most successful material combination was a lattice-matched  $\text{Ga}_{0.5}\text{In}_{0.5}\text{P}/\text{Ga}_{0.99}\text{In}_{0.01}\text{As}/\text{Ge}$  (1.88, 1.41, 0.68 eV) solar cell which has reached efficiencies up to 40.1%.<sup>[3]</sup>

At Fraunhofer ISE we have followed an alternative approach which enables the use of lattice-mismatched semiconductor materials. In this case the lattice constant is intentionally graded between Ge and - in our case -  $\text{Ga}_{0.83}\text{In}_{0.17}\text{As}$  with a bandgap energy of 1.17 eV.

The challenge of this structure is to completely relax the mismatched crystal layers in a region of the device where no photocurrent is generated. In the ideal case misfit dislocations are only formed inside a spatially defined buffer region (see Fig. 4) and threading dislocations are sufficiently suppressed. This approach is called metamorphic as starting from Ge the crystal is transformed into a virtually new lattice with a 1.2 % larger lattice constant. This new lattice acts as the template for the growth of a  $\text{Ga}_{0.35}\text{In}_{0.65}\text{P}$  top and  $\text{Ga}_{0.83}\text{In}_{0.17}\text{As}$  middle cell structure which are both lattice-matched to each other. The resulting solar cell is composed of semiconductors with bandgap energies of 1.65, 1.17, 0.68 eV which is close to the theoretical optimum for a device with three pn-junctions.

It has to be emphasized again that

The challenge of this structure is to completely relax the mismatched crystal layers in a region of the device where no photocurrent is generated. In the ideal case misfit dislocations are only formed inside a spatially defined buffer region and threading dislocations are sufficiently suppressed

the success of the metamorphic approach relies on the material quality that can be achieved in the photoactive parts of the solar cell structure. Therefore, the graded buffer layer is a key for achieving excellent device performance.

Our best metamorphic triple-junction solar cells are reaching efficiencies of 41.1 % (see Fig. 5) under 454 suns concentration<sup>[4]</sup>, and they demonstrate the high theoretical potential as well as excellent material quality which can be realized with metamorphic growth.

Still there is sufficient room for further improvements of this structure. As an example some of the most important R&D topics are the development of:

- dislocation blocking layers surrounding the buffer structure

to further reduce defect densities in the active solar cell layers

- high bandgap tunnel diodes between the subcells to reduce losses due to absorption and reflection
- back surface passivation of the Ge bottom cell to improve the photocurrent of this subcell
- a broad-band anti-reflection coating which covers the full spectral range between 300 – 1850 nm
- contact fingers with higher aspect ratio to minimize shadowing losses

The potential of the metamorphic  $\text{Ga}_{0.35}\text{In}_{0.65}\text{P}/\text{Ga}_{0.83}\text{In}_{0.17}\text{As}/\text{Ge}$  triple-junction solar cell has been shown to be high and excellent device characteristics can already be achieved.

Figure 4

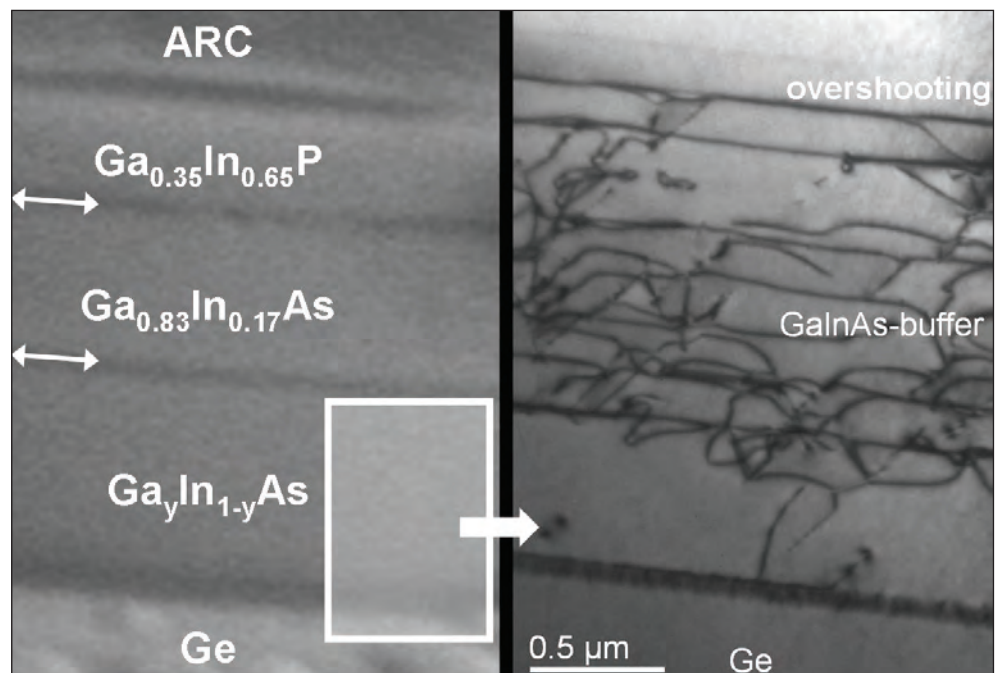

For the application in a concentrator PV system, the influences of optical elements and the operating temperature of the cells have to be considered. In the future the development of multi-junction solar cells may be more directed towards a maximum power output of a specific concentrator system rather than increasing the cell performance under the standard AM1.5d spectrum at 25 °C. This will help III-V semiconductors to be more successful in the new solar concentrator PV market with the potential to become a major player in the industry and to lower the cost of solar electricity.

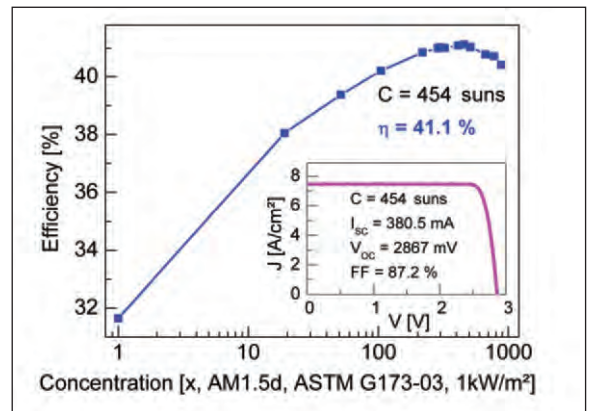
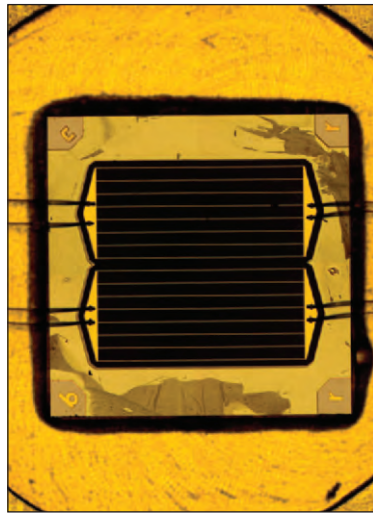

Above and right: Figure 5

References

- [1] A. W. Bett, F. Dimroth, and G. Siefert, "Multijunction Concentrator Solar Cells," in Concentrator Photovoltaics. Heidelberg, Germany: Springer Verlag, 2007, pp. 67-87.
- [2] F. Dimroth and S. Kurtz, "High-Efficiency Multijunction Solar Cells," MRS Bulletin, vol. 32, pp. 230-4, 2007.
- [3] R. R. King, D. C. Law, K. M. Edmondson, C. M. Fetzer, G. S. Kinsey, H. Yoon, R. A. Sherif, and N. H. Karam, "40% efficient metamorphic GaInP/GaInAs/Ge multijunction solar cells," Applied Physics Letters, vol. 90, pp. 183516-1 -3, 2007.
- [4] W. Guter, J. Schoene, S. P. Philipps, M. Steiner, G. Siefert, A. Wekkeli, E. Welser, E. Oliva, A. W. Bett, and F. Dimroth, "Current-matched triple-junction solar cell reaching 41.1% conversion efficiency under concentrated sunlight," Applied Physics Letters vol. 94, pp. 223504/1-3, 2009.

**Micro-Channel Pd Hydrogen Purifiers**

High Reliability + Low Cost of Ownership  
Ultra-pure Hydrogen from Almost Any H<sub>2</sub> Source

**PE9000S Series**

**New Z-Purge Cabinet Option**

99.999999% (<1 ppb total)  
Capacity 30 – 1400 slpm  
(2 – 84 Nm<sup>3</sup>/hr)

Lowest Power Consumption  
Highest Hydrogen Efficiency  
Auto Start-up and Shut-down  
Point of Use / Central Purifier  
Compact: 24”h x 21”w x 18”d  
(626 x 540 x 458 mm)  
100-200 lbs (45-90 kg)



**PE2100 Series**

For Low Flow Applications  
Flow Capacities: 1-30 slpm  
He leak tested <10<sup>-9</sup> scc/sec  
Size: 10” x 10” x 8”  
(254 x 254 x 303 mm)  
14 lbs. (6.4 kg)

Manufactured by: **Power & Energy, Inc.**  
106 Railroad Drive Ivyland, PA 18974 USA  
Tel: +1 (215) 942-4600 Fax: +1 (215) 942-9300  
e-mail: [info@powerandenergy.com](mailto:info@powerandenergy.com)  
Visit our website: [www.powerandenergy.com](http://www.powerandenergy.com)



**Watlow® Delivers Heater Uniformity to Pump and Gas Lines**



The tight contact fit of Watlow's pump and gas line heaters provide, uniform heating up to 200°C for transfer lines.

Contact Watlow for the latest offering of custom engineered solutions specifically designed for your needs.



**Watlow GmbH**  
Tel: +49 (0) 7253 9400-0  
Fax: +49 (0) 7253 9400-900  
Web: [www.watlow.com/semicon](http://www.watlow.com/semicon)



# Photonic Integration: What is the Holy Grail?

It is popularly observed that the photonic industry actually survives on differentiation in device design and process in order to show superior performance. With hundreds of semiconductor laser designs that emit at 1550 nm or even 1310 nm, when will the industry agree on a common platform? **By Michael Leppy, President and CEO, OIDA.**

If photonic integration had come first, the metrics would be different...but it didn't. Electronics integration at the semiconductor level came first, and the silicon electronics industry set in stone the expectations of integration through vehicles such as Moore's Law. Tracking the number of transistors that comprise a microprocessor over the last three decades is a metric that the electronics industry takes seriously... and it has achieved a level of success beyond what anyone would have imagined even twenty years ago. So why would it have been different if photonic integration had come first? Simply, integrating photonics functions is different. Photonic integration is typically specific to each application.

This implies that different photonic devices need to be integrated. On a general level, photonics is still at the analog stage while electronics, which utilizes analog transistor devices, actually uses them in a digital format. The digital format allows high levels of integration. Photonics has yet to achieve this digitized level of integration, and is currently in the analog domain. The Holy Grail for photonic integration is digitization.

The challenge is to predict when this will occur. We will need a strong application in the marketplace, but to ensure success, we might well need standardization and process equilibrium: the consolidation of different device structures to a few (rather like p-MOS, n-MOS to CMOS—complementary metal-oxide semiconductor—in the electronic semiconductor industry).

A review and synopsis of photonic integration over the last 30 years is shown in Figure 1. Photonic integration must utilize foundry-based technology in order to move past the analog regime into a digital regime. This will require common fabrication processes, devices, and technology, something that is almost heresy in the photonics world.

It is popularly observed that the photonic industry actually survives on differentiation in device design and process in order to show superior performance. With hundreds of semiconductor laser designs that emit at 1550 nm or even 1310 nm, when will the industry agree on a common platform? When will the industry agree on a DFB laser that, for example, accomplishes 80% of the specifications needed on most telecom systems equipment?

Digitization is the agreement on common platforms. Digitization is the Holy Grail for photonic integration. Digitization must occur for photonic integration to become an accepted technology platform for broad product applications. When will the photonics industry see analog functions architecturally in a digitized format?

## 2.0 Photonic Integration: Introduction and definition

Photonic integration typically means the integration many different types of optical components such as lasers, modulators, detectors, multiplexers, optical amplifiers, etc. It can be monolithic or hybrid, and there are many varieties and options. The majority of solutions have resorted to hybrid approaches, rather than the traditional monolithic approach. Monolithic approaches in photonics are challenging, especially if

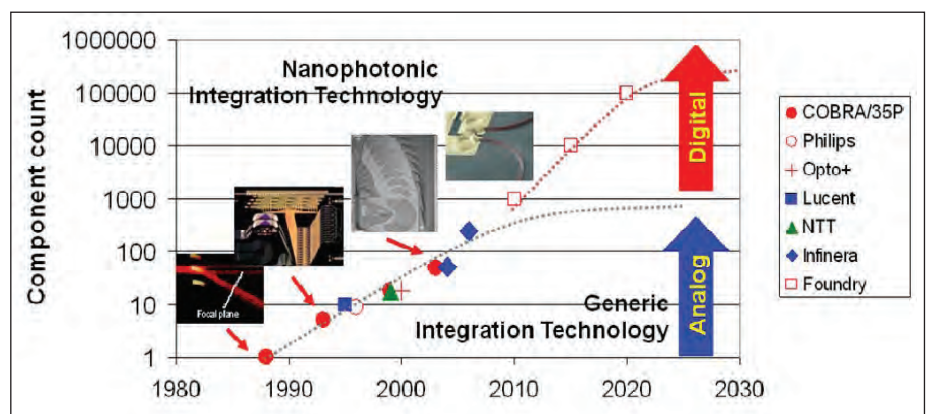

Figure 1: Roadmap shows component count versus year and rise of digitization over analog photonic integration solutions (Meint Smit, TUIe, OIDA Photonic Integration Forum, Oct 2008)

both electronic and photonic devices are considered. In fact, over the last two decades, the original term optoelectronic integrated circuit (OEIC) has been superseded by the term photonic integrated circuit (PIC). PICs today do not incorporate electronics; when they do, the term may evolve to a different acronym.

The traditional definitions for photonic integration are noted below, followed by newer definitions as the industry is beginning to adopt a more organized approach with A-PICs, OE-PICs, etc.

### 3.0: Drivers for photonic integration

Technology, whose development is to be pursued for commercial rather than scientific reasons, should enable tangible economic and technological benefits. This is certainly the case for PICs, which promise important benefits across a wide range of attributes. At the simplest level, the case for PICs parallels that for silicon ICs: the ability to monolithically integrate many distinct devices and functions onto a common chip vs. using many discrete components, thereby delivering important gains in packaging efficiency, smaller size and lower power use, increased reliability, and very importantly, lower cost per device. It has been continually argued, however, that the benefits of PICs go beyond simple densification and cost reduction; they enable increased functionality. This increased functionality drives end-user value by enabling the addition of cost-effective functions that would otherwise not be economically viable, or technically possible, to incorporate. This superior value has been demonstrated many times in the telecommunications fiber optic component segment. It has also provided two arguments for promoting the use of photonic integration: performance gains (space, power reliability, and cost) as well as increased functionality.

While the benefits of larger-scale photonic integration have been conceptualized since the invention of the IC, practical implementation and commercial deployment have taken several decades due to difficulties related to device design,

#### Traditional definitions:

##### Photonic Lightwave Circuits (PLC):

These are circuits based on passive waveguide components that are integrated on the same substrate. PLCs do not include active devices. Most solutions to date use silica as the platform material to maximize the benefit of the passive photonic function. It has been difficult to utilize silica material for emitters and electronic functions, which has limited the architectures to passive solutions. Modulators (without lasers) in the traditional definition are considered passive devices.

##### Photonic Integrated Circuits (PIC):

PICs in the classic sense are passive and active waveguide optical components integrated on the same substrate without electronics. Typical materials for PICs are InP, GaAs, and more recently silicon. Techniques such as wafer bonding of III-V materials that have emitting properties with silicon are allowing new vehicles for both photonic and electronic functionality.

**Optoelectronic Integrated Circuits (OEIC):** OEICs are circuits that contain both passive and active waveguide optical components integrated on the same substrate, but also with electronic components such as field effect and bipolar transistors. Typical materials for OEICs have been III-V compounds such as InP and GaAs, but with the recent developments of hybrid devices, silicon is beginning to find a home in this category.

#### New definitions:

##### Active or Optoelectronic PICs (A-PICs or OE-PICs):

Such circuits enable the integration of optoelectronics functions and require an electrical contact (i.e., lasers, PIN detectors, modulators, switches, variable optical attenuators, and amplifiers) in addition to supporting passive functions (i.e., waveguides, filters, and multiplexers). The material of choice for these PICs is indium phosphide (InP) or gallium arsenide (GaAs) based materials owing to the ability of these materials to generate, amplify, or detect light in the 850 nm, 1310 nm, or 1500 nm fiber optic transmission windows, as well as to provide passive waveguides that are transparent at these wavelengths.

##### All-Optical or Passive PICs (OO-PIC) –

**the OO refers to optical in; optical out:** Such circuits are typically called planar lightwave circuits (PLC) that integrate purely passive functions such as waveguides, filters, and multiplexers. The material of choice for these types of PICs is silica on silicon, or, in the case of modulators, lithium niobate. These PICs may be integrated using hybrid integration with active devices or PICs (for example, PIN photodiode arrays used in silica-on-silicon PLC-based reconfigurable optical add/drop multiplexers, or ROADMs).

##### Optoelectronic Integrated Circuit (OEIC) or Electronic-PIC (EPIC):

Such circuits include electronic circuits which are different from A-PICs, OE-PICs, and OO-PICs, which consider only the integration of optical component functions. OEICs integrate both photonic components (either “active” or “passive” functions) with purely electronic circuits—essentially the combination of photonic IC and silicon IC functions. Typical electrical-only functions that may be implemented on an OEIC include circuitry for laser or modulator drivers, trans-impedance amplifiers (TIA), clock-data recovery (CDR), or digital logic circuits similar to those implemented in silicon ICs.

The traditional definitions are closely aligned to materials and substrate platforms, while the newer definitions are aligned along functional solutions. The industry today uses a combination of terms, although most practitioners still utilize the traditional definitions.



manufacturing uniformity, and commercial challenges. While optical components can be built using many materials, including indium phosphide (InP), gallium arsenide (GaAs), lithium niobate (LiNbO3), silicon (Si), and silica-on-silicon, widespread use of large-scale PICs has to-date been limited to those built in either silica-on-silicon or InP.

#### 4.0 Functional attributes of photonic integration

A monolithically integrated photonic integrated circuit consolidates many devices and/or functions into a single photonic material. As in electronic semiconductor ICs, the fabrication of monolithic PICs involves building devices into a common substrate so that all photonic couplings occur within the substrate and all functions are consolidated into a single, physically unique device.

Historically, many technologies have experienced, through their lifecycle, initial size reductions for a similar function. These size reductions have generally involved hybrid assembly. In a hybrid assembled PIC, multiple single or multi-function optical devices are assembled into a single package, sometimes with associated electronic ICs, and are interconnected to each other by electronic and/or optical couplings internal to the package. Generally, the assembly of hybrid integrated components is more complex than for monolithically integrated PICs due to the need to interconnect multiple discrete devices with sub-micron tolerances required for aligning optical components. Adding to the packaging challenge is the fact that different materials may require different packaging designs due to differences in optical, mechanical, and thermal characteristics.

For example, if two materials have different coefficients of expansion, they can become misaligned at different operating temperatures and require different thermo-electric coolers, thus compounding

Functional Attributes	Types of Integration		
	Module Integration	Packaging Integration (Hybrid Integration)	Monolithic Integration
Description	Integrate discrete devices and packages into a common module	Integrate multiple discrete optical and/or electrical devices into a single package	Integrate multiple devices and/or functions into a single optical “chip” and package
Combine electronic IC and photonic functions (OEIC)	++++	+++	Difficult in practice
Integrate different optical materials	++++	+++	++
Integrate different optical functions	++++	++++	++++
Consolidation of electrical connections	+	++	+++
Consolidation of optical connections	+	+	++++
Fiber coupling consolidation	+	++	++++
Testing consolidation	+	++	++++
Packaging consolidation	+	+++	++++
Size/Footprint savings	+	+++	++++
Reliability Improvement	+	++	++++
Power consumption savings	+	++	++++

Table 1: Different levels of photonic integration offer differing level of benefits depending on the degree of integration achieved (Infinera)

packaging complexity and cost. In practice, this has limited hybrid PICs integration levels in the 10s of devices. Many integrated photonic devices available today, however, utilize hybrid integration to consolidate packaging of both photonic and electronic ICs, and a number have increased component counts to the low 100s.

To better understand the types of photonic integration technologies, Table 1 compares key metrics relevant to photonic integrated circuits.

#### 5.0 Scale of photonic integration

In a manner similar to that developed to categorize silicon ICs, the degree of optical integration achieved in a photonic integrated circuit can be categorized based on how many distinct devices and/or functions are integrated into a single device. The

categorizations below provide a reference on the scale of photonic integration achieved based on how many optical devices/functions are integrated:

**Small-scale PICs (SS-PICs):** These circuits range from 2 to 10 functions or components integrated into a single monolithic substrate. Examples include lasers with integrated modulator and maybe some ancillary components like rear-facet PIN monitor, variable optical attenuators (VOA), or tuning element. Small-scale PICs typically only integrate a few functions for a single wavelength, or several channels of the same device (i.e., laser diode or PIN arrays).

**Medium-scale PICs:** These circuits range from about 10 to 100 functions or components integrated into a single monolithic substrate. This can include the

if two materials have different coefficients of expansion, they can become misaligned at different operating temperatures and require different thermo-electric coolers, thus compounding packaging complexity and cost

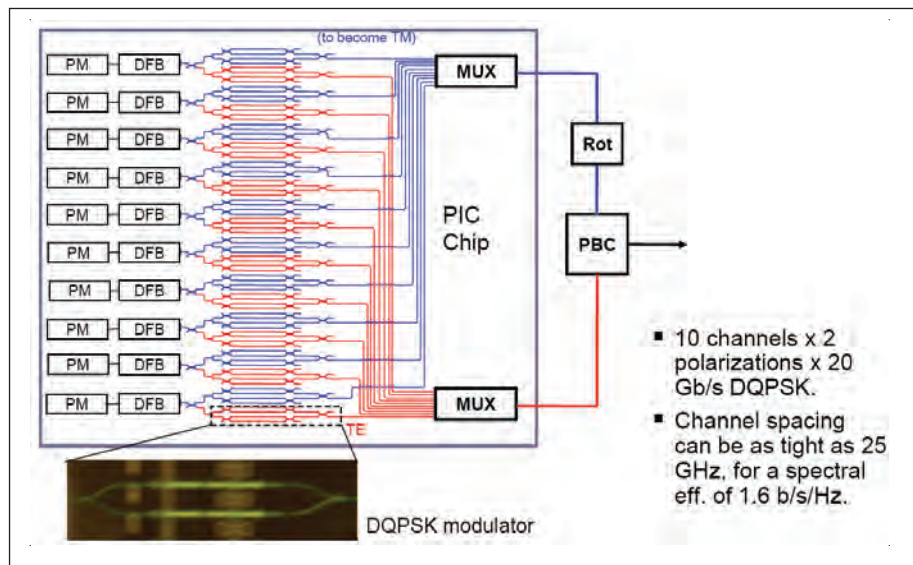

Figure 2: Prototype PM-DPSK transmitter with 282 functional elements (Infinera)

addition of several functions for a single wavelength channel and even some small level of parallelism (i.e., multiple functions duplicated across multiple channels). Large-scale PICs: These circuits will be above 100 functions or components integrated into a single monolithic substrate, which may imply the integration of several functions for a single wavelength channel as well as a high degree of parallelism (i.e., 10+ channels per PIC). A good example is shown in Figure 2, a 282 functional element prototype PM-DQPSK transmitter in InP.

Very large-scale PICs: These circuits will be above 1000 functions or components

integrated into a single monolithic substrate. This could include the integration of functions as well as wavelengths, but nevertheless is probably the barrier to digital-based PICs, and thus might be referred to as the Holy Grail for PICs.

### 6.0 Materials platforms for photonic integration

A wide variety of materials platforms exist which offer the possibility of photonic integration, and these generally mirror the materials used in the construction of both active and passive optical components.

Individual component devices that make up

an integrated photonic circuit are generally best made from materials of different bandgaps and junction placements. For example, laser material must enable efficient light emission under forward bias, modulator material should allow low and high attenuation in the “on” and “off” states under reverse bias, and passive waveguides require a material with minimal absorption. A multitude of successful material integration methods exist for photonic integration. Optical components are built using many materials including indium phosphide (InP), gallium arsenide (GaAs), lithium niobate (LiNbO3), silicon (Si), and silica-on-silicon. Photonic integration derives its value from the ability to unify as many disparate functions into a single material platform, and thereby deliver maximum impact on system cost and functionality.

Lithium niobate has, to date, allowed small-scale photonic integration of several components. Devices have been built that integrate multiple Mach-Zehnder modulators and associated waveguides and couplers on a single substrate, for example. Complex processing requirements and size limitations, however, may preclude it from being a material of choice for scaling to medium or large-scale integration. Furthermore, lithium niobate faces severe technical challenges to practically implement active optoelectronics functions like lasers and detectors, thus limiting its potential to integrate the entire range of desired photonic functions.

Silicon, or silicon-on-insulator (SOI), has shown promise as a materials platform for the large-scale integration of passive optical devices such as arrayed waveguide gratings (AWG), optical switches, and VOAs. In recent years, integration of active devices have been commercialized—such as lasers, amplifiers, modulators, and photodetectors—which offer potential for low cost PICs. In addition, silicon photonic integrated circuits can be built using standard CMOS processes and therefore hold the promise for enabling both optical and electronic integration.

### Passive PIC Products Are Widely Used

- AWGs Have Been Shipped In Volume For Almost 10 Years, Integrating 40 Filters
- Subsequently More Integrated Products With More Than 100 Functions Are Standard
  - VMUX, ROADM, OCM

Mux/DeMux, Heaters & Sensors

Integrated Switch/VOA Array

Integrated ROADM

Figure 3: Commercial PLC-based integrated ROADMs showing integrated switch/VOA arrays packaged into a ROADM sub-system module (NeoPhotonics)



Silica-on-silicon has been used as the material of choice for the fabrication of planar waveguide circuits (PLC) which enable the integration of a large number of passive optical functions. PLCs that integrate more than 100 passive optical functions on a single chip are currently in routine production. Examples are chips integrating optical couplers, switches, VOAs, and monitor taps for use in ROADMs applications, and chips integrating multiple AWGs for use in wavelength selective switch (WSS) applications. Excellent examples of passive PIC products are shown in Figure 3.

Silicon is an indirect band gap material, which means that implementing active opto-electronics functions such as lasing and light detection will be more complex. Innovative approaches have included the use of novel material doping, different polycrystalline structures, and/or the need for external optical pumps. In the meantime, the relative maturity and ease of manufacture of this technology for use in implementing passive optical functions has led to the increasing use of silicon-based planar lightwave circuits (PLC) for integrating "all-optical" functions such as ROADMs.

Photonic integrated circuits can also be implemented using III-V materials having a direct band gap such as InP or GaAs. These materials inherently support light emission and detection, and can be used to integrate lasing, amplification, and detection functions that are important to implementing optical-to-electrical-to-optical (OEO) conversions. For example, GaAs allows the fabrication and integration of active optoelectronics devices in the 850 nm telecom window. Clear benefits are the short-reach optical transmission applications including chip-to-chip, computer-to-computer interconnections, and local area networks.

Indium phosphide and its many ternary, quaternary and pentenary alloys have demonstrated the ability to marry the reliable integration of both active and passive optical devices operating in the 1310 nm or 1550 nm telecom windows. InP supports light generation, amplification, modulation, detection, variable attenuation, and switching in addition to passive functions such as wavelength (de-)multiplexing, optical routing, and polarization control. This enables all the main optoelectronics

functions required in an optical transport system to be monolithically integrated into an optical "system-on-a-chip" that can provide substantial benefits versus the use of many discrete optical devices.

A strong and growing player for PICs over the past few years is monolithic-hybrid

integration. Here, III-V material is wafer bonded (adhesive or molecular) to a prepared substrate, most commonly SOI, and then further processed using modified or standard CMOS process technologies. In this case, the small critical dimension and high optical confinement of SOI may be combined with the light emitting and

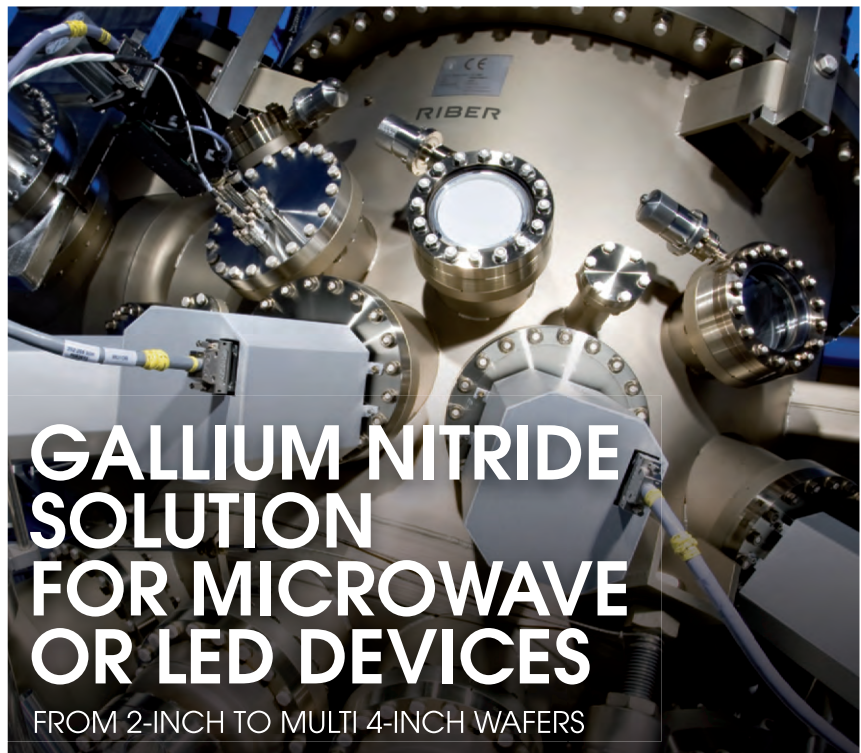

## GALLIUM NITRIDE SOLUTION FOR MICROWAVE OR LED DEVICES

FROM 2-INCH TO MULTI 4-INCH WAFERS

### **R Innovative Reactors**

From research to production

### **R Flexibility in the nitrogen sources**

RF nitrogen plasma source  
Ammonia delivery module

### **R Full-Service Process Technology Center (PTC)**

Accompanies you to start up through growth demonstration and wafer characterization

To find out more, please contact us today at:

**e-mail: [info@riber.com](mailto:info@riber.com)**

**[www.riber.com](http://www.riber.com)**

RIBER - 31, rue Casimir Périer - 95873 Bezons cedex - France

Tel: +33 (0) 1 39 96 65 00 / Fax: +33 (0) 1 39 47 45 62

INNOVATIVE SOLUTIONS FOR SEMICONDUCTOR INDUSTRY

**RIBER**

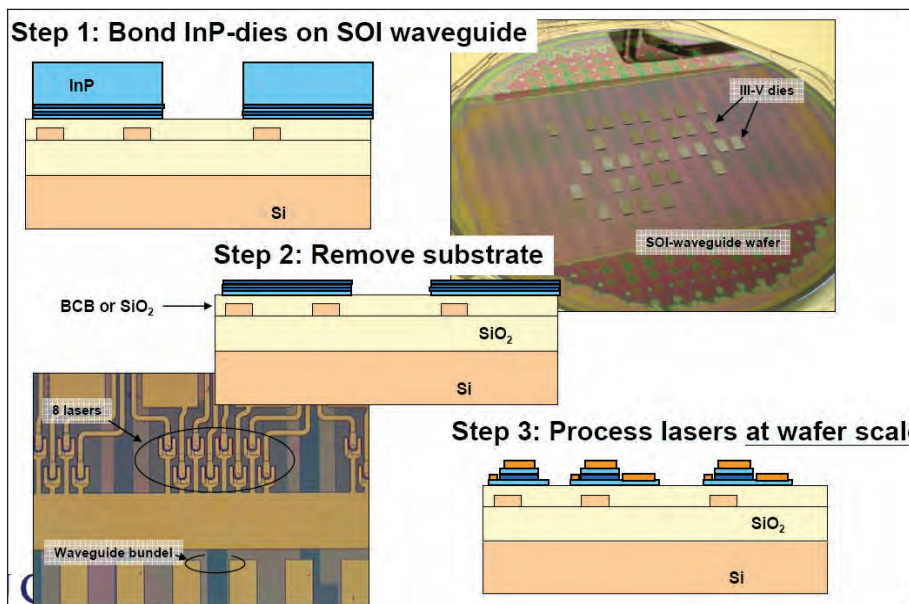

Figure 4: Monolithic hybrid PIC platform combining CMOS and wafer bonded III-Vs (IMEC, Ghent, OIDA Photonic Integration Forum, Oct 2008).

detecting properties of III-Vs. An example is shown from European researchers in Figure 4.

### 7.0 Has the reliability of PICs advanced for digitization?

As with any new technology, reliability needs to be proved beyond a shadow of a doubt in order to carry traffic. The progress with InP PICs has been terrific to date, and is probably ready for digitization if and when the process technology advances to the level of maturity needed. Indium phosphide is now proving to be an excellent platform for integration as can be seen in Figure 5.

Currently deployed InP PICs implemented by Infinera to support 100 Gbps WDM per chip have demonstrated more than 100 million service hours with no failures. This puts the FIT rate for a > 50 functional component, PIC, at < 10 FIT for a 60% confidence level. This compares well to field data from discrete commercial 980 nm Pump Chips: 74 FIT @ 60% CL (H. Pfeiffer et al, OFC 2002) or 5 FIT (G. Yang, et al, JDSU, JWA30, OFC 2007). Improved reliability in PICs is being seen as one of the strongest drivers to grow photonic

Figure 5: The FIT rate at 60% confidence over time as PICs continue to be employed in communication networks (Infinera)

integration toward the Holy Grail of digitization.

### 8.0 The Holy Grail for photonics integration is coming

To better access the potential of reaching the Holy Grail for photonic integration, roadmaps need to be generated...derived by the industry and academia. There are presently only a few trend graphs for

photonic integration, and perhaps this is a call to further explore the area between analog device integration and digitized integration for photonics. Two important trend graphs are discussed below that address photonic integration both from a component as well as a functional standpoint (using wavelength). Although the component devices have changed in nature and structure over time for PICs in fiber-based communications, the capacity that a single die can deliver doubled every 2.2 years during the 90s with time division multiplexed (TDM) communication networks. This is seen in Figure 6: the two round dots, lower left, for EML devices. Wavelength division multiplexed (WDM) integration on a single die allows for even more rapid growth using the pure III-V material system.

Figure 6 also shows the logarithm of data capacity in Gbps in the first year of deployment for commercial devices with solid diamond data points. Research devices and their predicted rate of development are shown with open diamond data points.

The trend for future performance is a log scale extrapolation from the reported highest capacity III-V prototypes reported in 2004 and 2008. There are a number of ways trend graphs can be shown, and in Figure 7, the trend towards large scale photonic integration is shown to be

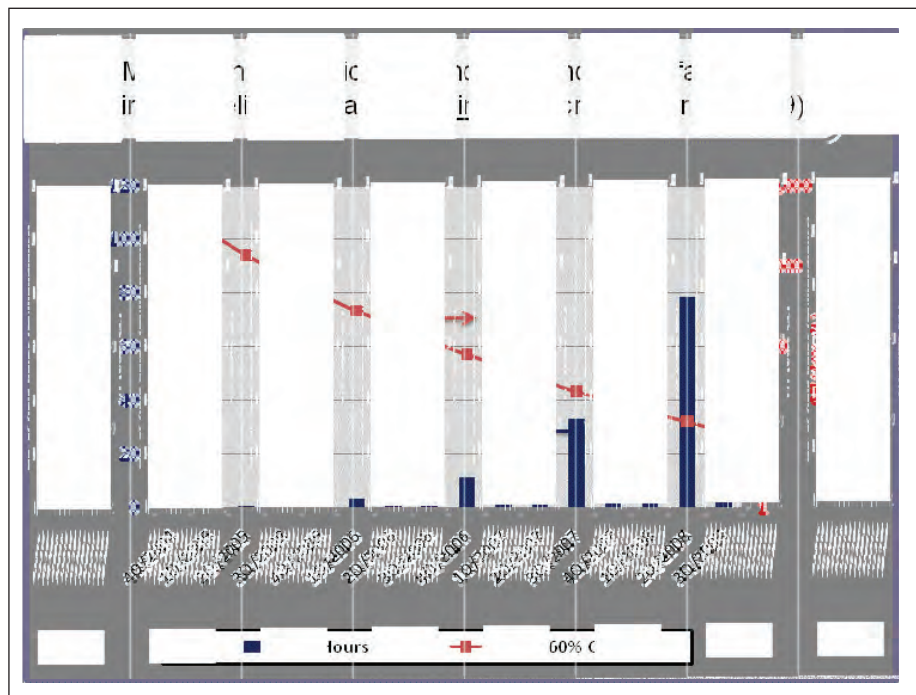



progressing quickly. The graph shows that by 2010, technology leaders should be in a position to address very large scale photonics integration, and perhaps digitization.

### 9.0 Metrics for PIC trend maps and roadmaps

The obvious way to address future trends is component count, with small, medium, large and very large scale integration metrics. An area in which photonics works well is functional count and functional integration. In functional count, active and passive functions are counted separately. Short definitions of active and passive functional components are provided below:

**“Active” components:** These are optoelectronics functions that require an electrical contact, such as lasers, PIN detectors, modulators, switches, VOAs, and amplifiers. A current (forward potential) may be injected into an active device to generate light by conversion from electrical to optical at a pn junction. A current may also be applied to change the local index of a component. A voltage (reverse potential) may be applied through an electrical contact to enable energy conversion from optical to electrical at a pn junction. A voltage can be used to change the local index of a component or to change the optical absorption properties of the material. A current may be applied through a resistive medium to change the local temperature of a device, which may or may not be the same material as the optical path material system. Most active elements have separate contacts for sourcing and sinking current. It should be clear that it is the function count, not the contact count that is tracked.

**“Passive” components:** These components enable purely passive functions such as waveguides, filters, power dividers, and multiplexers. Passive devices may indeed have electrical contacts in some cases for tweaking or tuning of the device performance. These electrical tuning functions are slow acting relative to the data rate of information being transported through them (often thermal in nature) and can be “set and forget” for the life of the device. These tuning functions are separate active elements from the passive device function.

It is possible to measure the technical level of advancement of the integration platform by aggregating the total number of active

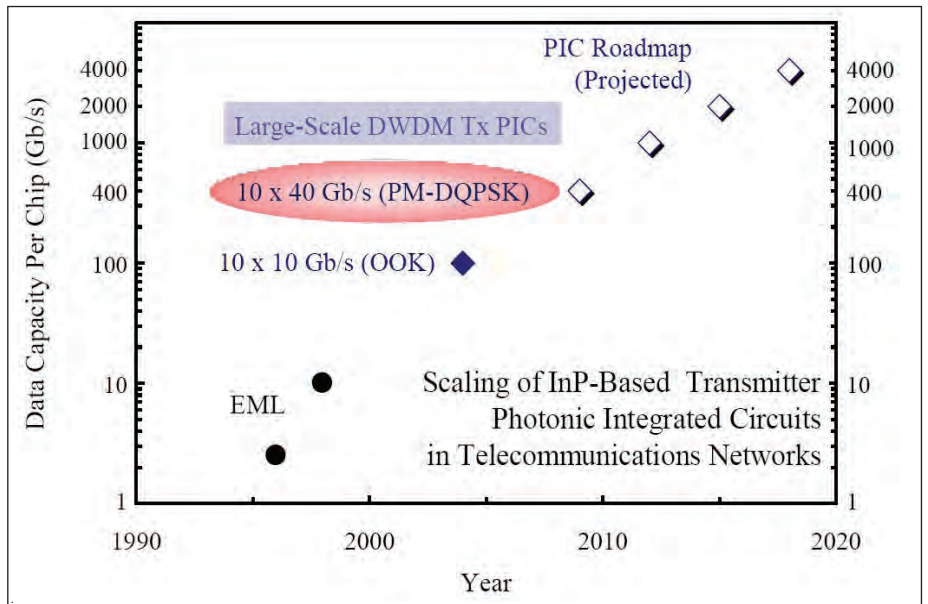

Figure 6: Scaling of InP-based transmitter PICs in telecommunication networks (Infirera, OIDA Photonic Integration Forum, Oct 2008)

and passive functions on a yielded optical die regardless of the die's application as a system or subsystem in an optical network. The philosophical intent is to track the beneficial effect of reduced defect density. Counting each device that can have a different failure mode is an easily applied technique which is independent of the method of counting random and systematic “killer” defects. One issue with this approach is that each

passive device is defined as one function regardless of the number of inputs and outputs. For example, an AWG which has 8 input and 8 output arms counts as one function, as does a similar AWG with 1000 input and output arms. The larger AWG may then have a greater chance of sustaining a killer defect than the smaller AWG. It may seem incorrect to count each device as one; however, as practical circuits get more complex, they will need larger and larger

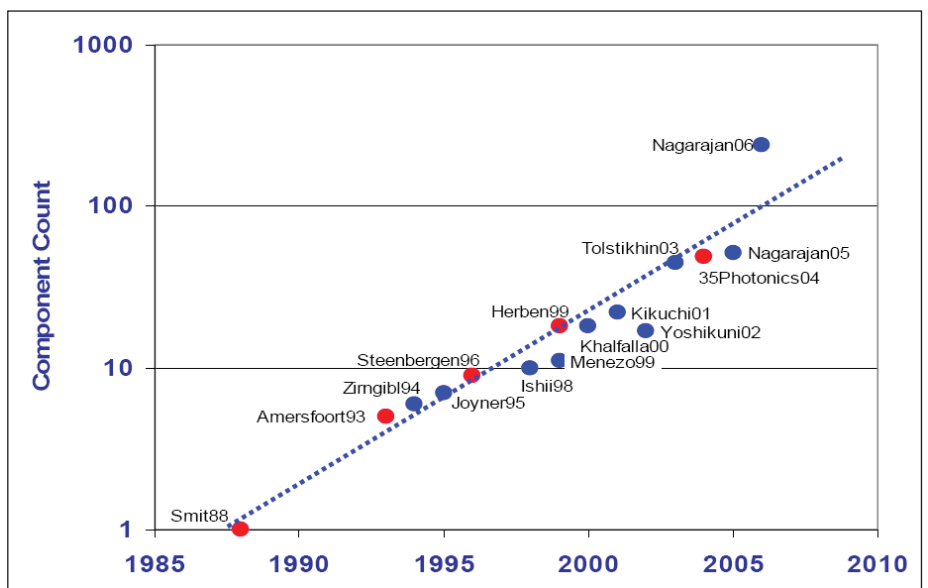

Figure 7: Moore's Law component count of functions per die vs. time for research prototypes (TU/e, OIDA Photonic Integration Forum, Oct 2008)

Metric	Application				
	Telecom (WDM Transport)	Telecom (WDM Switching)	Telecom (FTTx)	Datacom	Computing
Transmission Capacity per chip (Gb/s)	1,000	10,000	100	500	1,000
Capacity-reach product per chip (Gb/s-km)	100,000	10,000	1,000	5,000	100,000
Components/functions integrated per chip (#)	500	750	100	1,000	5,000
Integrated functions per chip (#)	50	100	10	500	1,000
Reliability (FIT)	<10	<10	<10	<20	<20
Manufacturability (% yield)	50	60	90	75	85
Power per Gb/s	20mW	50mW	50mW	5mW	5mW
Capacity (Gb/s) per size (mm <sup>2</sup> )	100-200	200-400	10-20	50-100	250-500
Cost (\$ per Gb/s)	10-30	1-10	0.5-1	0.2-0.5	0.3-0.6

Table 2: Key required areas of continued research and development in photonic integration

passive routing, multiplexing, and other functions. The same yield management improvements that enable higher active counts support larger passive elements, as well. In general, the size of shared passive elements will scale with the active element count. A single 1000 x 1000 port AWG die may not be as significant an achievement as one in which numerous active functions are multiplexed through that AWG on the same die. It is hoped that if this method is followed, all yielded die will be treated with similar rules.

Table 2 identifies key required areas of continued research and development in photonic integration and might be considered the beginning of a roadmap toward digitization.

### 10.0 Summary

If photonic integration had come first, the metrics would be different...but it didn't. The photonic integration community needs to redefine integration metrics for the industry. Road and trend maps are good

vehicles to accomplish this. Unfortunately, the route to full digitization in photonic integration will be slow given the traditional metrics from the semiconductor IC industry. With the progress of analog photonic devices and demonstrated levels of component and functional integration in the order of 100s, full digitization in photonics is still probably 5-10 years away. To accelerate the progress, there must be industry-wide efforts in the following areas:

- address common fabrication and process techniques
- better simulation tools to standardize device structures
- agreement in the industry for common devices with less custom specifications
- agreement in the photonic industry to utilize foundries
- common road and trend maps for both academia and industry

While a volume application is needed to bring competitive cost structures to photonic integration circuits, progress

toward digitization will occur when economics are part of the design process: the design for low cost functionality. The massive application will certainly drive a cost-efficient solution; standardization will allow the production to be decoupled from the design as in foundry manufacturing.

It is hoped that large photonic foundries which operate on standard materials, processes, and design rules will permit mass production of highly complicated but more efficient PICs with building block architecture to feed those massive applications.

Digitization is the vehicle to unify the photonic integration industry. It may allow new metrics such as flops/sec, a common metric seen today in silicon digital processors, to appear in photonic-based systems. Only then will the Holy Grail of photonic integration be possible. Photonic integration has yet to achieve this digitized level of integration, and is currently in the analog domain from a functional as well as component standpoint.

A single 1000 x 1000 port AWG die may not be as significant an achievement as one in which numerous active functions are multiplexed through that AWG on the same die



Increasing the operating frequency of transmitters and detectors can produce a range of benefits. These include communication at higher data rates and identification of objects that are highly absorbing at these higher frequencies. Imaging systems can also be improved, because switching to higher frequencies can slash the size of these systems.

The latter benefit has encouraged the US Defense Advanced Research Projects Agency (DARPA) to fund two consecutive programs that require the re-defining of the state-of-the-art for high-frequency transistors and associated circuits. The first, Sub-millimeter Wave Imaging Focal Plane Technology (SWIFT), kicked-off in February 2006 with the goal of building an imaging system operating

at 340 GHz, a frequency window of low absorption from atmospheric gases. Imaging systems at this frequency promise to offer two significant benefits over existing equivalents at other frequencies. Imagers operating at far higher frequencies are of limited use in dusty, foggy and smoky conditions, and 340 GHz systems could deliver far more informative images, thanks to greater penetration of the radiation at this frequency. Imagers at the 340GHz frequency should also be far more compact than lower frequency counterparts operating at millimeter waves, because it should be possible to realize the same spatial resolution with an aperture that is an order of magnitude smaller.

This substantial reduction in aperture

size is a very important consideration for many government applications, according to DARPA program manager John Albrecht. "Consider a helicopter attempting to navigate a dust storm. While millimeter-wave radiation offers a way to see through the dust, the size of the millimeter wave imager – generally about one meter – is too large to be practical. A sub-millimeter-wave imager can do the job with an aperture size that will fit onto the platform."

The first phase of the SWIFT program focused on the development of 340 GHz amplifiers and detectors. Efforts were restricted to III-V technologies, because these can form compact devices that are easily integrated with other pieces of electronics. Most of the targets for

*DARPA's funding of the development of the building blocks for imaging systems based on sub-millimeter wave frequencies could aid US helicopter pilots in dusty, foggy and smoky conditions. CREDIT: US Navy*

## DARPA propels InP electronics towards a terahertz

DARPA is driving the development of ultra-high-frequency emitters and receivers based on InP HEMTs and HBTs. If successful, this effort could ultimately lead to the manufacture of imaging systems that enable helicopter pilots to navigate with greater confidence in foggy, smoky and dusty conditions. **Richard Stevenson investigates.**



Teledyne Scientific and Imaging is developing HBT-based circuits for DARPA's terahertz electronics program. Teledyne has a strong background in this technology, having already built 325 GHz InP HBT power amplifiers delivering 2.1 mW at 6.1 % power-added efficiency

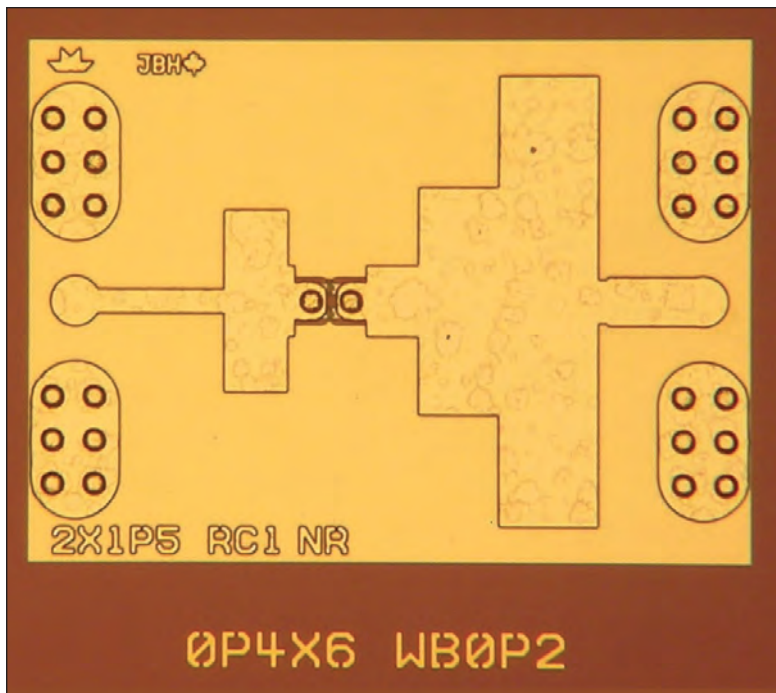

the first phase were realized, with those involved pioneering the fabrication of amplifiers and oscillators operating at frequencies above 300 GHz. "In the process, new infrastructure, benchmarks and metrology were created that will open the sub-millimeter wave frequency domain for future designs and systems," says Albrecht.

More than 60 publications have stemmed from these achievements, which have included the development of 35 nm InP HEMTs, 0.3 μm-emitter HBTs, and monolithic integrated circuits operating at sub-millimeter wave frequencies. The only elusive goal was that of a 50 mW output power for the power amplifier.

### Exceeding expectations

Given the great successes in phase I of the program, one would expect the funding of the second phase to be a formality. But this has not happened because DARPA believes that the best way forward is to pursue even more ambitious targets. "The device technology achieved unexpectedly high gain of typically 8dB per stage

at 340 GHz, and suggested that much higher frequencies in transistor electronics were feasible," explains Albrecht. "This was the inspiration that led to a new program entitled terahertz electronics." Its ultimate aim is to treble the operating frequency of the devices in the SWIFT program, while maintaining their impressive power, noise figure and bandwidth characteristics. However, it's not just a follow-on to SWIFT, says Albrecht: "The objective is to develop the critical device and integration technologies to realize compact, high-performance electronic circuits operating at center frequencies exceeding 1.0 terahertz."

One of the key contractors in both of DARPA's programs is Northrop Grumman Aerospace Systems (NGAS). This company hit the headlines in late 2007 with the claim for the world's first terahertz transistor. The results produced by its ground-breaking InP HEMT were presented at the International Electron Devices Meeting (IEDM), and Northrop Grumman now has an entry in the Guinness World

Records.

"What we've accomplished since then is to build a suite of circuits that demonstrate all the major active functions that you would need in the 340 GHz window," explains Richard Lai, the head of the company's microelectronics products. This includes fundamental oscillators for creating sub-millimeter-wave frequency sources, power amplifiers for boosting their intensity, and low-noise amplifiers (LNAs) that increase the intensity of a signal before it is detected. The IEDM results were obtained on-wafer, and packages have now been developed to house these chips.

The IEDM presentation included details of a LNA that produced 15 dB of gain at 340 GHz. Since then this amplifier's operating frequency has been increased to 350 GHz, and it has been packaged into gain blocks with waveguides for coupling radiation in to and out of the chip.

A more recent edition to Northrop Grumman's product portfolio is a 10 mW power amplifier. Lai says that the fabrication of this amplifier was one of the biggest challenges of the program. The InP HEMTs used in this type of amplifier have a relatively low breakdown voltage, and consequently a relatively low power density, so fingers are added to boost the output.

NGAS embarked on the terahertz electronics program in April 2009, and it is now working towards the phase I targets, which are defined at 670 GHz (see table for details). Researchers are in the middle of performing some fundamental device studies, and they are looking to exploit HEMT and HBT technologies.

DARPA is also funding another team on its terahertz electronic program, which is being led by Teledyne Scientific and Imaging. This firm played a smaller role in the SWIFT



program - building an amplifier that produced a couple of milliWatts at 340 GHz. In addition, it has been a key participant in the Technology for Frequency Agile Digitally Synthesized Transmitters (TFAST) program, which has helped it to hone its expertise in high-frequency electronics. The TFAST project demanded the development of transistors with cut-off frequencies of up to 500 GHz, and fabrication of complex circuits based on these devices. 100 transistors are needed in very fast dividers, and 5000 are used to make digital synthesizers. "They had yield goals as well," explains Bobby Brar, executive director of the electronics division at Teledyne. "End-of-program goals were 50-60 percent yield."

Teledyne produced these circuits with InP HBTs, a technology that it will use throughout the terahertz electronics program. According to Brar, one of the advantages of using the HBT, rather than the HEMT, is that it can be used to build all the circuits needed by the program. "If successful, we would have one circuit that would be monolithic. And that's a big deal, because getting on and off a chip at those kinds of frequencies is non-trivial." Another advantage of the HBT is that it can be manufactured with much tighter threshold voltages than a HEMT, which simplifies the design of digital blocks, dividers and mixers. In addition, the problems associated with parasitics are less of a challenge when scaling HBTs.

### Teledyne's partners

Teledyne carries out everything from the fabrication of devices to chip packaging, and many of its partners in the terahertz electronics project are there to provide guidance when needed. If the company runs into problems related to transistors or circuits, then it can turn to Mark Rosker at the University of California, Santa Barbara. And if it is experiencing difficulties related to the coupling of electromagnetic radiation

on to the chip, or off of it, then it can consult with Gabriel Rebeiz from the University of California, San Diego. The Jet Propulsion Laboratory is another important team member in Teledyne's effort, and its role is to measure the device and circuit performance. Brar says that the team at the Jet Propulsion Laboratory is a world leader for this type of measurement, which is essential for meeting the program goals. The final member of the team is Raytheon. Its expertise lies with systems, rather than components, and it is well positioned to advise on how to apply the technology.

To increase the operating frequencies of its HBTs, Teledyne is shrinking device dimensions. "Making smaller dimensions is a piece of cake these days," claims Brar. "But you have got to make sure that you scale your transistors in such a way that you get good contact resistances, low parasitic capacitances, and low leakage currents." Teledyne is able to draw on the work of others regarding approaches to scale InP bipolar transistors. "Mark Rodwell has essentially published a roadmap for scaling InP bipolar, so we know what the challenges are," says Brar.

Reducing parasitic resistances is one of the bigger challenges. Preventing any increase in overall resistance during the scaling process requires

improvements in contact resistances that are commensurate with reductions in area. Realizing this gets tougher and tougher as the devices get smaller, because the periphery dimensions increase relative to those of the bulk as the transistor is scaled. "If you have good junctions that are well-passivated at 0.5  $\mu\text{m}$  emitter dimensions, at 125 nm the problem becomes at least four times worse," says Brar. "The area has shrunk, but the perimeter-to-area ratio has increased."

Another challenge facing the engineers involved in the terahertz electronics program relates to circuit design. Care is needed to avoid issues cropping up at higher frequencies that have no impact at tens of gigahertz. "Having done the work at 340 GHz, we are confident that we can handle those kinds of problems," says Brar. Potential pitfalls include losses in the semiconductors, and issues that arise because the dimensions of the substrate are comparable to the wavelength of the radiation. The latter can lead to the excitation of modes that hamper coupling of radiation between the chip and the outside environment.

Teledyne is still to publish its best results, but Brar says that they are "pretty close" to the goals at 670 GHz. He believes that it will not be

*DARPA has set go, no go (GNG) targets for each of the three phases of its terahertz electronics program*

Metric		Unit	Phase I	Phase II	Phase III
<b>GNG Metrics</b>					
	<b>Center Operating Frequency</b>	<b>GHz</b>	<b>670<sup>(1)</sup></b>	<b>850<sup>(1)</sup></b>	<b>1030<sup>(1)</sup></b>
<b>Area I: Exciter/Receiver</b>	Exciter P <sub>out</sub>	dBm	4	2	0
	Exciter Phase Noise <sup>(2)</sup>	dBc/Hz	-33	-30	-27
	Exciter Modulation Bandwidth	GHz	15	15	15
	Exciter Slew Rate	GHz/ms	15	15	15
	Receiver NF	dB	12	12	12
	Receiver Instantaneous Bandwidth <sup>(3)</sup>	GHz	15	15	15
	RF Yield <sup>(4)</sup>	%	50	50	50
<b>Area II: HPA</b>	P <sub>out</sub> <sup>(5)</sup>	dBm	18	14	10
	Power Added Efficiency	%	0.75	0.5	0.2
	Instantaneous Bandwidth <sup>(3)</sup>	GHz	15	15	15
	Gain	dB	20	18	16

long before his team is able to conceive of making circuits at this frequency. Values for the HBT's maximum oscillation frequency are closing in on one terahertz, and the cut-off frequencies are hitting half a terahertz.

### Similar outlooks

Brar and Lai both believe that one of the biggest challenges of the terahertz electronics program is the fabrication of waveguides for coupling the radiation in and out of the chips. Terahertz systems already exist in research labs, but they are very limited in the amount of power they can provide, because of the high losses at these frequencies. "We want to take power and sensitivity and improve it by several orders of magnitude," says Lai. Realizing this would redefine the types of systems and measurements that are possible.

Teledyne's approach, which Lai claims is similar to that of NGAS, involves fabrication of waveguides by silicon micro-machining. The radiation's wavelength is a fraction of a millimeter, so tolerances of tens of microns are needed for the features. "But smoothness tolerance are very important too," says Brar, as otherwise losses are unacceptably high.

Both teams are aiming to develop production processes with good yields, rather than embarking on a quest for a 'hero result' from a single, unreproducible device. "We're not a university," explains Brar. "We want to grow a technology that goes into a product." The efforts of him and his co-workers are already having an impact on lower-frequency devices, which can now be manufactured with greater control and uniformity.

NGAS is also starting to reap the rewards of its 35 nm gate process that has been used to produce hundreds of wafers. Circuits have been demonstrated with 25-30 transistor cells and 50-100 fingers with good functional and RF yield. And institutions such as the Jet Propulsion Laboratory have adopted the 35 nm process to make circuits operating at lower frequencies. "That shows the maturity of our process," says Lai. "We can take our device process, share the device models that we have, and others can go and design this stuff successfully." That means that DARPA's programs can be viewed as money well spent, an important virtue in tough economic times. Not only have these efforts improved transistor performance; they have started to impact the characteristics of systems operating at lower frequencies.

## Reprints are a valuable sales tool

### Benefit from a reprint featuring your company

They can be ordered after publication and can be customized to your exact needs. For more information and prices, contact the sales team now.

Tommy Beazley  
T: +44 (0)1923 690222  
E: tb@angelbcl.co.uk

Shehzad Munshi  
T: +44 (0)1923 690215  
E: sm@angelbcl.co.uk



Introducing <sup>the</sup> latest  
**masterpiece**  
in our collection  
**Compound Semiconductor**

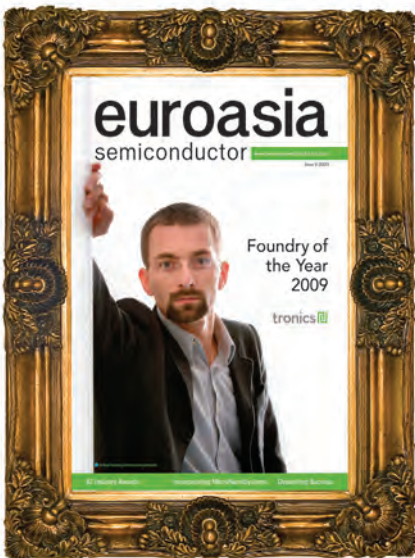

[eurosiasemiconductor.com](http://eurosiasemiconductor.com)



[compound  
semiconductor.net](http://compoundsemiconductor.net)



[solar-pv-management.com](http://solar-pv-management.com)

**Editorial, Advertising & Subscriptions**  
**+44 (0)1923 690200**

# Chipmakers will reap the rewards of an explosion in LED TV sales

Sales of LED-backlit TVs will rocket over the next five years, leading to domination of this market. **Richard Stevenson quizzes Strategies Unlimited's Robert Steele** on the reasons behind this tremendous growth, and its implications for LED chipmakers and MOCVD tool manufacturers.



LED-backlit LCD TVs with backlights based on an array of LEDs were launched onto the market back in 2004, and for the first few years they only delivered modest sales. "But this year the market is taking off," says Robert Steele, the director of the LED practice at market analyst Strategies Unlimited. He expects LED-backlit TVs to capture a two or three percent share of TVs sales this year, and rise at a staggering rate to take a market share of between 40 and 60 percent by 2013. By then LED sales will generate \$6 billion per year, which is \$1 billion more than the entire market for LEDs in 2009.

This hike in LED demand will deliver a tremendous benefit to the compound semiconductor community. It will not only drive up volumes for chipmakers – it will also increase sales of sapphire substrates, metal organic precursors and process and carrier gases. And MOCVD tool manufacturers such as Veeco and Aixtron will sell more reactors, thanks to the additional demand for LED chips.

The reason why it has taken five years for LED-based TVs to start to make a commercial impact is that the early versions were far too expensive. Sony was the first to market with this technology - in 2004 it had a domestic launch of this class of TV, which employed LEDs made by Philips Lumileds. The 40 inch version retailed for around \$7500, and the 46 inch sibling had a price tag of \$10,000. Prices have fallen since then,

LED backlighting units can deliver local dimming of the screen, leading to the reproduction of incredibly deep blacks. CREDIT: Philips



but some high-end models still cost several thousand dollars.

The current success in LED-based TV is being led by the Korean electronics giant Samsung, and Steele says that this company is expecting fast growth of this part of its business. Prices of its sets are far less than those of Sony – a 40-inch model can be picked up for just under \$1500, and some retailers are selling a 46-inch version for less than \$2000. This means that prices are still more than those for LCD TVs with cold cathode fluorescent (CCFL) backlights, but the additional premium to pay for this technology has fallen to just \$700-800, and it is projected to fall even further later this year and into 2010.

Steele points out that Samsung has entered this market aggressively, and backed the launch of its TVs with a marketing campaign that is reportedly worth tens of millions of dollars. He explains that this effort has been motivated by Samsung's decision to eventually exit the market for CCFL-backlit LCD TVs, which is tremendously competitive and operates on very small profit margins. LED backlit TVs promise to generate higher profits for the company, and help to promote the Samsung brand.

### Why buy an LED TV?

The primary benefits of buying LED-based TVs have shifted over the last couple of years. Originally the strength of this form of TV was superior picture quality. Samsung, for example, boasted of deeper blacks and outstanding contrast ratios in its 2008 models that employed a direct backlight approach.

However, in 2009 it is promoting the stylish thinness of its LED backlit sets, which have moved to an edge-lit approach. Both types of architecture eliminate mercury in the backlights, and Samsung claims that the switch from CCFLs to LEDs can also reduce power consumption by up to 40 percent.



Steele says that Samsung may sell as many as 2 million sets in 2009. However, he tempers that by adding that it is difficult to provide an accurate estimate of the company's sales for this year. Although Samsung has shipped many sets to retailers, some are just sitting on shelves and gathering dust. This is not surprising given the backdrop of a nasty recession, and shops that are full of discounts on all forms of TV. However, if Samsung decides to reduce the price difference of its sets over those built with CCFL backlights during the Christmas holiday season, then it could sell substantial numbers of TVs in the final few weeks of 2009.

Samsung has reduced the cost of its LED backlights by using white LEDs, rather than a combination of red, green and blue ones. Color mixing three sources is more complicated, according to Steele, because the output from each type of chip shifts with time, and this alters the color balance. So a feedback mechanism is employed to constantly maintain the optimum white light output, which involves measurements of the spectral output, followed by

adjustments to the driving conditions of the device. This is complex, and it adds to the production cost of the display.

In the past, TV manufacturers have shied away from using white LEDs, due to their limited color gamut. Traditionally, the white light output from the LED results from combining the blue emission from the chip with that produced from excitation of a yellow-emitting phosphor. This means that the emission in the red region of the visible spectrum is relatively dim. But this weakness can be overcome by using white LEDs that combine a blue emitting chip with red and green-emitting phosphors. "The stability of the phosphor is important," explains Steele, because any variations in output will lead to changes in the color balance of the white-emitting display.

### Back lit or edge lit?

Steele says that Samsung's first design of LED-backlight TV included a two-dimensional array of emitters. This enables local dimming of the screen, leading to excellent contrast ratios. However, Samsung has subsequently switched to an edge-lit

*Sharp is one of the leading manufacturers of LED-backlit TVs in Japan. Like Sony and Panasonic, it has no in-house chip production. CREDIT: Sharp*



*Samsung is leading the growth of LED backlit TVs, and it could sell up to 2 million of these sets in 2009*

architecture that substantially cuts the number of LEDs in the backlight. According to Steele, backlighting with a two dimensional array of LEDs directly behind the screen requires 1,000 to 2,000 devices, while side illumination uses several hundred. However, these need to be more powerful, and in this case the LEDs are driven at 50-60 mA, as opposed to 20 mA for LEDs in a two-dimensional array.

The very high LED content in both backlighting architectures leads Steele to estimate that this market will consume 46 billion devices in 2013, a staggering number that will put tremendous pressure on global chip-making capacity. Predicting which LED chipmakers will benefit the most from this explosion is tricky, partly because some TV makers can also manufacture their own chips. In addition, the drive currents are low and sophisticated packaging approaches are not required, so this market is not limited to those

manufacturers capable of producing state-of-the-art LEDs. And it is an attractive market to be in, because Steele says that it should offer reasonable profit margins to chip makers and LED packaging firms.

LED-backlit TV manufacturers such as Samsung and LG can produce LEDs in house, and they are looking to increase their internal capacity. Samsung reportedly plans to order 100 MOCVD reactors over the next few years, and LG will add an additional 50.

However, these companies will also use additional sources for LED chips, according to Steele. Samsung currently orders LED chips mainly from Epistar in Taiwan, and also from Formosa Epitaxy and Seoul Semiconductor, all of which are running at full capacity. LG buys chips primarily from Cree, and it may also be placing orders with Seoul Semiconductor.

The leading Japanese manufacturers of LED-backlit TVs - Sharp, Sony and Panasonic - do not have any internal LED production, and Steele believes that they are likely to use the domestic supplier Nichia, and possibly the European chipmaker Osram. There are also manufacturers of LED-backlit LCD panels in Taiwan, such as AU Optronics and Chi Mei. Steele says that both of these companies are gearing up to have large internal chip capacities, while buying chips from outside suppliers in the near term.

The LED-based TV is destined for market dominance, but will it enjoy a long reign at the top? Absolutely, says Steele, who can see substantial weaknesses in the alternatives. He expects interest in projection TVs - whether they are based on lasers or LEDs - to decline, and says that plasma TVs are in trouble. Although they offer an excellent picture, they are "energy hogs".

CCFLs are fighting back: they are able to produce a wider color gamut than in the past; prices are coming down; and some CCFL-backlit LCD TV panels have been demonstrated with widths of just 14 mm. However, Steele says these advances are still not enough to prevent the meteoric rise of the LED-backlit TV. CCFLs have already given way to LEDs in laptops, and he believes that there is no reason whatsoever why the same will not happen with TVs.

If he's right, this is fantastic news for LED chipmakers and all of their associated material and tool suppliers - although the credit crunch is biting very hard, the opportunity for substantial growth is on the horizon, and this business should be a healthy one for many years to come.

Steele estimates that the LED TV market will consume 46 billion LEDs in 2013



# Vertical architecture cranks up UV output

A partnership between Asif Khan's group at the University of South Carolina and its spin-off, Nitek, claim to have developed ultra-violet LEDs with a record output for a single chip.

These thin-film devices that feature a vertical injection architecture deliver a continuous wave output of 5.5 mW at 280 nm. "We soon expect to double [the output power]", adds Khan.

The researchers' effort will aid the development of ultra-violet LEDs that could replace mercury lamps for air, water, and food purification; for bio-medical treatments; and for polymer curing. Fabrication of ultra-violet LEDs begins with the growth of a 0.3  $\mu\text{m}$  thick AlN layer, a 10 period AlN/AlGa<sub>n</sub> superlattice and an active region with five quantum wells that is sandwiched between n-type and p-type layers. These layers are deposited on a sapphire substrate by a combination of pulsed atomic layer epitaxy and MOCVD.

Focusing an excimer laser through the substrate leads to dissociation at the AlN/sapphire interface. "The entire epilayer peels off from the sapphire substrate," explains Khan. A Ni/Au layer forms the LED's p-contact, and the n-contact is added by first exposing the n-type AlGa<sub>n</sub> layer by reactive ion etching, before defining a Ti/Al grid on this surface.

An unsaturated, continuous-wave output of 5.5 mW was realized at a 250 mA drive current. This corresponds to a current density of 25 mA cm<sup>-2</sup>, a relatively low value that leads to minimal self-heating and thermal degradation. Light output is

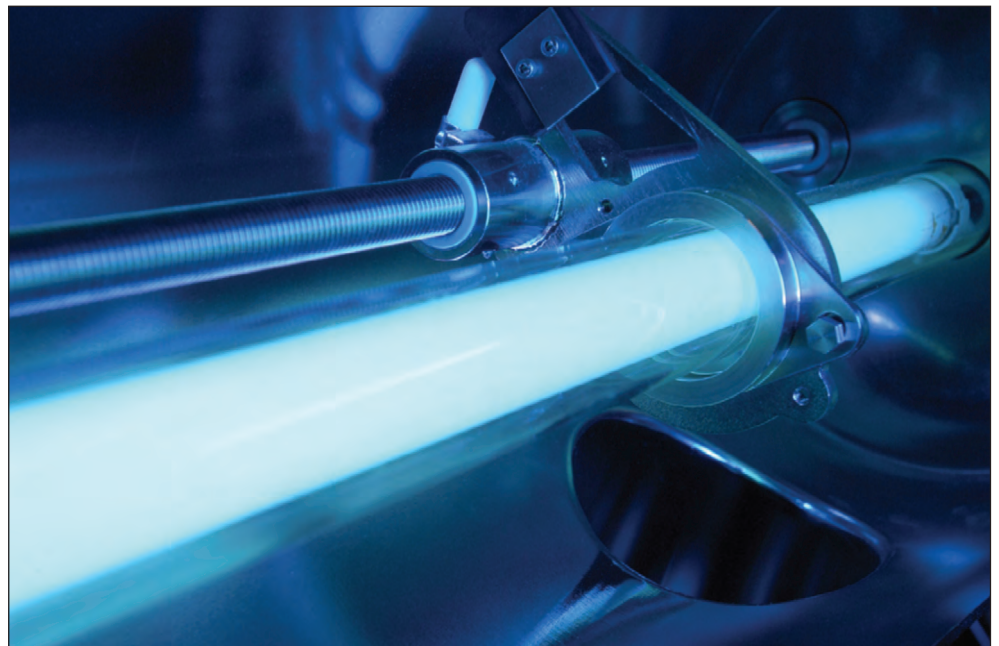
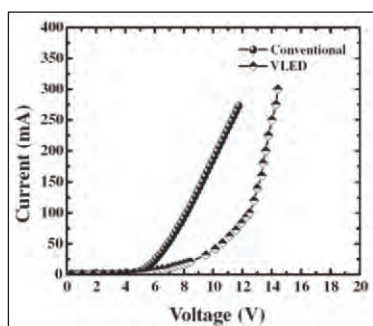

uniformly distributed over the emitting surface, thanks to the absence of current crowding.

No appreciable change in output power was observed when the device was driven at a current density of 25 mA cm<sup>-2</sup> for 210 hours. Extrapolating the output power as a function of time led to an estimate of device lifetime of well over 2000 hours. "Our next series of improved devices are being put on lifetest, and we will keep measuring them for a few months to get the actual numbers, rather than extrapolations," explains Khan.

"Our next target is to monolithically combine these vertical LEDs, and see how much total power we can get." Other goals include the roughening of the n-type AlGa<sub>n</sub> layer, which could lead to a tripling of the chip's output power, and an increase in the overall efficiency of electrical to optical conversion.

V. Adivarahan et al.  
Appl. Phys. Express 2 092102

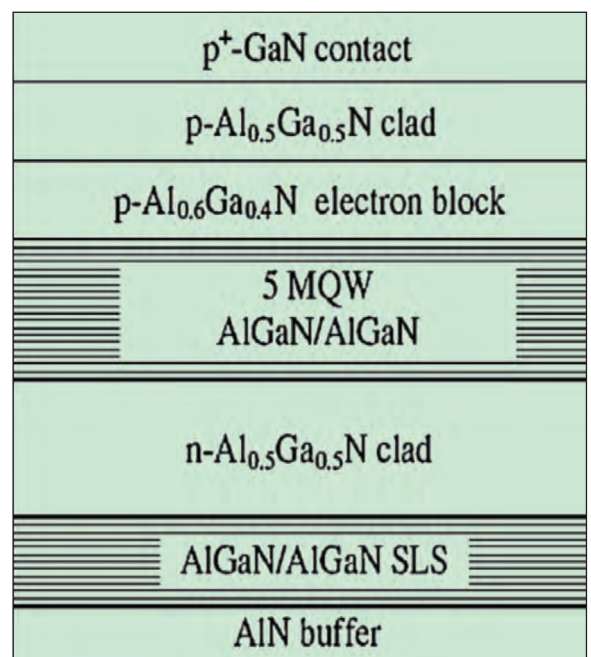

Top: Ultra-violet lamps are widely used for water purification, but LEDs could replace this technology if their efficiencies are improved. CREDIT: Hanovia. Bottom: Ultra-violet LEDs with a vertical carrier injection architecture promise to unlock the door to single chip output powers of tens of mW.

# Koreans slam Auger as the primary cause of LED droop

A Korean partnership has joined the controversial debate over the origin of LED droop. It claims that its sophisticated approach to curve fitting of experimental data demonstrates that Auger recombination only makes a small contribution to droop, the decline in GaN LED external quantum efficiency at higher current densities.

This team from Inha University and Hanyang University arrived at this conclusion by manipulating the standard rate equations, and reducing fit parameters from three to just one. Selecting a suitable value for the Shockley-Read-Hall (SRH) non-radiative recombination coefficient generated a value for Auger recombination (the non-radiative interaction of an electron, a hole, and a third carrier) that is substantially different from that quoted by those backing Auger as the cause of LED droop.

To slash the number of fit parameters to just one, the researchers assumed an injection efficiency of 100 percent.

In addition, they exploited the fact that the gradient of the peak of the internal quantum efficiency as a function of drive current is zero at the maximum value for efficiency. This allowed the construction of new equations that related the rates for SRH recombination, bimolecular radiative recombination, and Auger recombination to the quantum well thickness and the maximum values for current density and internal quantum efficiency.

Experimental results were obtained by taking a 460 nm LED produced by a domestic supplier, and measuring its internal quantum efficiency as a function of drive current. This supplier also provided a value for the quantum well thickness, and the researchers

determined the non-radiative carrier lifetime from time-resolved photoluminescence measurements. Lead author Han-Youl Ryu says that this type of photoluminescence measurement could not be used on the LED chips. "Instead, we performed the measurement on an LED wafer with similar layer structures, and estimated the non-radiative carrier lifetime to be about 50 ns."

The researchers then deduced an Auger recombination rate of  $10^{27}$  cm<sup>6</sup>/s, by assuming a maximum internal quantum efficiency of 79 percent, and determining the value for the SRH recombination rate from the non-radiative carrier lifetime measurements.

This value for the Auger recombination rate is at least 1000 times higher than that quoted by other groups that claim Auger is the primary cause of droop, and implies that an alternative non-radiative mechanism is needed to account for declining LED efficiencies at high drive currents.

H.-Y Ryu et al. (2009) *Appl. Phys. Lett.* **95** 081114

# Patterned sapphire creates semi-polar GaN

Researchers from Yamaguchi University, Japan, have produced semi-polar (11 $\bar{2}$ 2) GaN on a maskless r-plane patterned sapphire surface. Their advance could help to spur the development of green-emitting devices that are grown on the semi-polar planes of GaN. These faces enable the fabrication of epistuctures that are not hampered by strong internal electric fields, and they facilitate the growth of InGaIn layers with a high enough indium content for green emission.

This Japanese team is not the first to grow semi-polar GaN on patterned, foreign substrates. Silicon has also been used, but this has the downside of absorbing some of the light that is generated by the device.

Fabrication of a series of semi-polar GaN films began with the creation of micron-sized grooves in sapphire via a combination of photolithography and fluorine-based inductively coupled plasma reactive-ion

etching. A 30 nm thick GaN buffer was then deposited onto this substrate by MOCVD at 460°C, followed by the growth of GaN at temperatures ranging from 900°C to 1000°C. Lower deposition temperatures created an undesirable mixture of (11 $\bar{2}$ 2) and (112 0) GaN, but growth at 1000 °C produced (11 $\bar{2}$ 2) only. Cathodoluminescence measurements revealed a threading dislocation of more than  $3 \times 10^9$  cm<sup>-2</sup> in an n-doped layer.

The researchers have produced LEDs on this material with the processes that were initially developed for device fabrication on c-plane sapphire. "However, the

performances were inferior to that on c-sapphire," says Narihito Okada.

They now want to understand why the performances of LEDs grown on the semi-polar and non-polar planes are inferior to those grown on the c-plane. However, the primary goal of this research team is to grow high-quality GaN layers with defect density below  $10^8$  cm<sup>-2</sup>.

N. Okada et al. (2009) *Appl. Phys. Express* **2** 091001

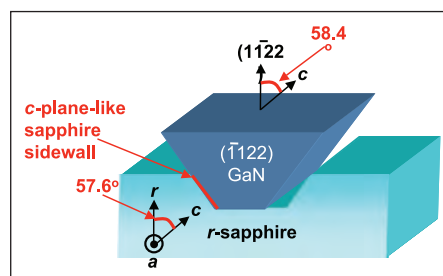

Fig1: Photolithography and etching forms groove in a sapphire substrate with a depth of up to 1 μm, and groove and terrace widths of 3 μm. Subsequent growth of GaN forms a semi-polar film

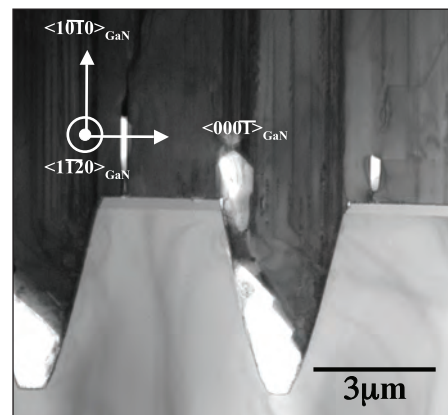

Fig2: MOCVD growth of GaN at 1000 °C creates semi-polar material with a high crystal quality



**Corporate Partnership**

T: + 44 (0) 1923 690 200

E: [tb@angelbcl.co.uk](mailto:tb@angelbcl.co.uk)

**AIXTRON**

Tel +49 241 89 09 0  
Fax +49 241 89 09 40  
E-mail [info@aixtron.com](mailto:info@aixtron.com) Web [www.aixtron.com](http://www.aixtron.com)

**LOGITECH**  
Materials Technologists & Engineers

Tel +44 01389 875444 Fax +44 01389 890956  
E-mail [darren.savery@logitech.uk.com](mailto:darren.savery@logitech.uk.com)  
Web [www.logitech.uk.com](http://www.logitech.uk.com)

**Temescal**

Tel +1 925 245 5817 Fax +1 925 449 4096  
E-mail [lyell.warren@edwardsvacuum.com](mailto:lyell.warren@edwardsvacuum.com)  
Web [www.temescal.net](http://www.temescal.net)

**Veeco**

Solutions for a nanoscale world.™

Tel +1 516 677 0200  
Fax +1 516 714 1200  
E-mail [info@veeco.com](mailto:info@veeco.com) Web [www.veeco.com](http://www.veeco.com)

**RIBER**

Tel +33 1 39 96 65 00  
Fax +33 1 39 47 45 62  
E-mail [info@riber.com](mailto:info@riber.com) Web [www.riber.com/](http://www.riber.com/)

**kSA**

Tel +1 734 426 7977 Fax +1 734 426 7955  
E-mail [requestinfo@k-space.com](mailto:requestinfo@k-space.com)  
Web [www.k-space.com](http://www.k-space.com)

**WATLOW**

Tel +49 07253 94000 Fax +49 07253 9400901  
E-mail [info@watlow.de](mailto:info@watlow.de)  
Web [www.watlow.com](http://www.watlow.com)

**OXFORD**  
INSTRUMENTS

*The Business of Science®*

Tel +44 01934 837000 Fax +44 01934 837001  
E-mail [plasma.technology@oxinst.com](mailto:plasma.technology@oxinst.com)  
Web [www.oxford-instruments.com](http://www.oxford-instruments.com)

**JST**  
Manufacturing Inc.

Tel +1 208 377 1120 Fax +1 208 377 3645  
E-mail [sales@jstmf.com](mailto:sales@jstmf.com)  
Web [www.jstmf.com](http://www.jstmf.com)

**Bronkhorst®**  
HIGH-TECH

Tel +31 573 4588 00 Fax +31 573 4588 08  
E-mail [info@bronkhorst.com](mailto:info@bronkhorst.com)  
Web [www.bronkhorst.com](http://www.bronkhorst.com)

**UMC**  
UNITED MINERAL  
& CHEMICAL CORP.

Tel +1 201 507 3300 Fax +1 201 507 1506  
E-mail [inquiry@umccorp.com](mailto:inquiry@umccorp.com)  
Web [www.umccorp.com](http://www.umccorp.com)

**Nitride Crystals, Inc.**

Tel +1 631 242 8853 Fax +1 631 242 8906  
E-mail [hhelava@optonline.net](mailto:hhelava@optonline.net)  
Web [www.nitride-crystals.com](http://www.nitride-crystals.com)

**III/V-Reclaim** (GaAs InP)

Tel +49 8728 911 093  
Fax +49 8728 911 156  
E-mail [reclaim@t-online.de](mailto:reclaim@t-online.de) Web [www.35reclaim.de](http://www.35reclaim.de)

**axt**

Tel +1 510 683 5900 Fax +1 510 353 0668  
E-mail [sales@AXT.com](mailto:sales@AXT.com)  
Web [www.axt.com](http://www.axt.com)

**SOF**  
GAS PURIFIER AND IPE EQUIPMENT

Tel +49 2403 519333  
Fax +49 2403 508968  
E-mail [info@sof-e.com](mailto:info@sof-e.com) Web [www.web.sof-e.com](http://www.web.sof-e.com)

**INSACO**  
INC

Tel +1 215 536 3500  
Fax +1 215 536 7750  
E-mail [sales@insaco.com](mailto:sales@insaco.com) Web [www.insaco.com](http://www.insaco.com)

**TANKEBLUE**

Tel +8610 6267 2372 ext 617 Fax +8610 6267 2371  
E-mail [TKHD-Sales@tankeblue.com](mailto:TKHD-Sales@tankeblue.com)  
Web [www.tankeblue.com](http://www.tankeblue.com)

**AkzoNobel**  
Tomorrow's Answers Today

Tel +1 800 828 7929 Fax +1 312 544 7188  
E-mail [metalorganics@akzonobel-pc.com](mailto:metalorganics@akzonobel-pc.com)  
Web [www.akzonobel-hpmpo.com](http://www.akzonobel-hpmpo.com)

**Vistec**

Tel +49 03641 651955 Fax +49 03641 651922  
E-mail [electron-beam@vistec-semi.com](mailto:electron-beam@vistec-semi.com)  
Web [www.vistec-semi.com/](http://www.vistec-semi.com/)

**TECDIA**

Tel +1 408 748 0100 Fax +1 408 748 0111  
E-mail [sales@tecdia.com](mailto:sales@tecdia.com)  
Web [www.tecdia.com](http://www.tecdia.com)

**IntelliEPI**

Tel +1 972 234 0068 Fax +1 972 234 0069  
E-mail [info@intelliypi.com](mailto:info@intelliypi.com)  
Web [www.intelliypi.com](http://www.intelliypi.com)

# No Guesswork...

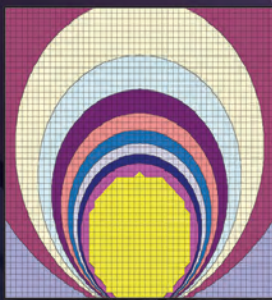

22 47.90

**Ti**

Titanium

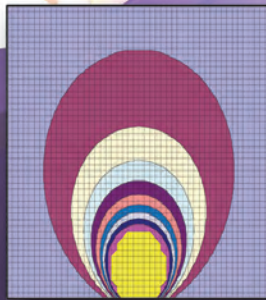

78 195.09

**Pt**

Platinum

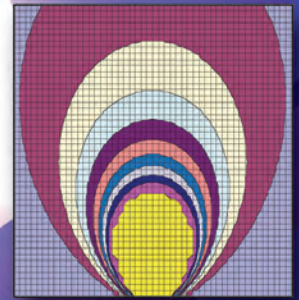

79 196.97

**Au**

Gold

# Problem Solved... Temescal



**Compound Semi**

## Experts in <sup>^</sup> Metallization

Temescal process scientists have developed a library of *Elemental Knowledge™*. This has led to 3D modeling of metal vapor clouds that enables Temescal to build tools that will optimize your process. A Temescal tool is more than just an Evaporator: the TCS (Temescal Control System) provides the Process Engineer unique control transforming the tool into a simple push-button system.

**We've done your EVAPORATION homework for you™**

*Temescal*

[www.temescal.net](http://www.temescal.net)